

FSL 6060 USER BOOK

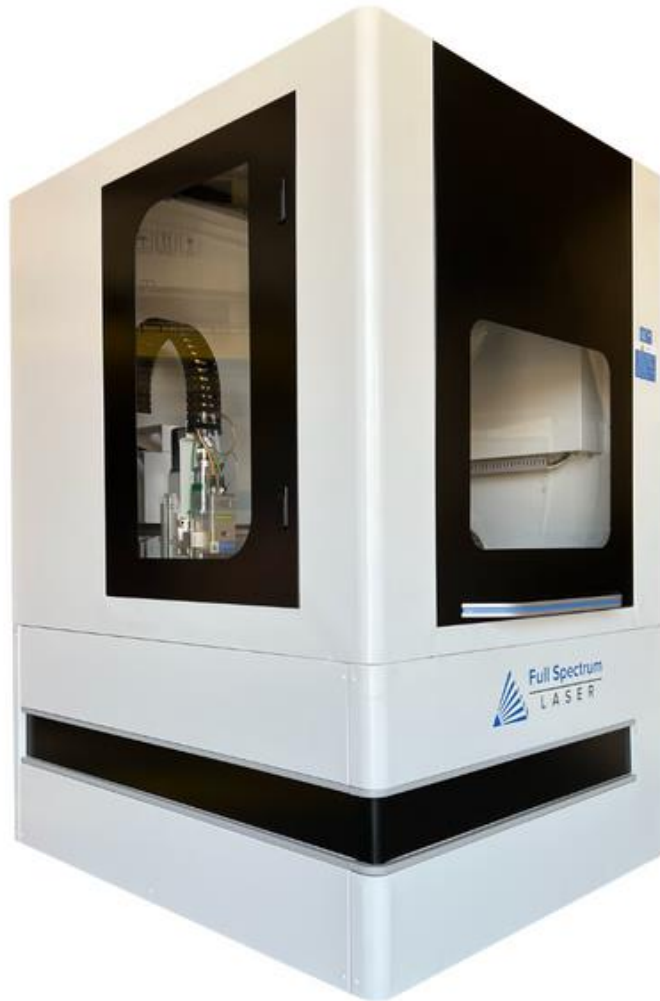

Foreword

Thank you for choosing to use the CN series fiber cutting machine produced by FULL SPECTRUM. We will provide you with comprehensive after-sales service and solutions. Please keep this manual and other accessories in good condition so that you can use this product better.

This manual is only applicable to the standard configuration of our products. For special customized products, please read the attached instructions carefully.

This manual will provide you with instructions on how the product works, how to install it, how to use it, how to troubleshoot it, how to transport it, how to maintain it, and how to maintain it. If you are using this product for the first time, please be sure to read this manual in detail. Improper use may cause the machine to operate abnormally. Failure, lowering the service life, and even equipment damage. Personal injury or death!

Due to the continuous improvement of the products, the products you receive may differ from the statements in this manual in some respects. Apologize!

In order to use this product quickly and effectively, the operator must have the following conditions:

First : The operator needs certain computer expertise, and will use the relevant editing and drawing software. The operating system supports AI. DXF. PLT. Gerber. LXD and other graphic data formats, accepting international standards generated by software such as MAster Cam, Type3, JDPaint, and Wentai. G code.

Second: Before using this equipment, please master the operation methods of the equipment and understand the operation status of each part of the equipment. The correct operation is an effective measure to ensure the normal operation of the equipment and personal safety. □

The operator of the laser cutting machine must be specially trained to a certain level and can be put into operation with the consent of the safety administrator.

The operator of the laser cutting machine or the person approaching the laser during the use of the laser should wear appropriate laser protective glasses. In the area where the protective glasses are worn, there must be good indoor illumination to ensure smooth operation of the operator.

Directory

Foreword.....	1
Chapter 1 Overview	1
Chapter 2 Safety Instructions and Precautions.....	2
2.1 Security Management Notice	2
2.2 laser safety protection	2
2.3 Electrical Safety Precautions.....	3
Warming!	3
2.4 Preparation materials before installation.....	4
2.5 Workshop size preparation before installation	5
2.6 Machine's use condition	6
2.7 Unloading requirements	7
2.8 Precautions for unpacking.....	9
2.9 Checking the content.....	9
2.10 Engineers install and training services	9
Chapter 3 Instructions for Using the Machine	10
3.1 switch machine steps.....	10
3.2 software operation process	11
3.3 operation of capacitor heightener	15
3.4 cutting head debugging method and common sense	25
3.5 Process parameter debugging method.....	32
Chapter 4 Maintenance	41
Review	41
4.1 Daily maintenance and maintenance of peripheral equipment.....	43
4.2 The maintenance of laser source and laser cutting head	45
Chapter 5 Common fault analysis	51
5.1 software enters the demo interface failure	51
5.2 The laser source doesn't have light	52
5.3 The light of Scanning and cutting out is not normal, Light leakage	54
5.4 The cutting process is not the right size	55
5.5 Cutting deviation.....	55
5.6 Cannot perform breakpoint positioning after power failure or restart	56
5.7 Height adjuster network timeout.....	56
5.8 Homing is not normal	59
5.9 Axis movement is not normal	60
5.10 The capacitance has always changed to 0	60
5.11 The body capacitance becomes smaller	61
5.12 The laser head direct touch board	62
5.13 Capacitance frequent alarm during processing	63
5.14 Cutting thin plate, thick plate edge jitter	63
5.15 Following the cutting process is getting higher and higher.....	64
5.16 The lifting height is getting lower and lower during the cutting process	64
5.17 Floating head calibration can not be marked.....	64

5.18	When the piercing height is greater than 3mm, the piercing process is not performed ..	65
5.19	Servo overload alarm after the height adjuster returns to the origin	66
5.20	The up and down movement of the height adjuster moves in one direction	66
5.21	Adjuster floating head calibration failed	67
5.22	Height adjuster prompts to follow the error too large alarm	67
5.23	The height adjuster prompts the encoder to be unresponsive.....	67
5.24	Encoder abnormal motion	67
5.25	Cutting process problem	67
5.26	Analysis of deformation of cutting small holes (Small diameter and thick plate)	69
5.27	Solution for burr of workpiece when laser cutting low carbon steel.....	69
5.28	Analysis of burrs on workpieces when laser-cutting stainless steel and aluminum-zinc plates	69
5.29	Analysis of laser incompletely cut through state.....	70
5.30	Solution to abnormal sparks when cutting low carbon steel	70

Chapter 1 Overview

Laser cutting is a more advanced processing method used in the processing of metal materials. The CN series fiber laser cutting machine produced by our company adopts the world famous brand of fiber laser, laser cutting head, linear guide, rack and pinion, servo motor, numerical control system and other specifications.

The machine bed is made of high-strength integral welded body, After high temperature annealing and precision machining of large CNC gantry milling machines, it has excellent rigidity, stability and shock resistance.

The beam uses aerospace standard aviation aluminum, it is formed by 4300 tons press extrusion molding. After aging treatment, its strength can reach 6061 T6 which is the strongest strength of all gantries. Aviation aluminum has many advantages, such as good toughness, light weight, corrosion resistance, anti-oxidation, low density, and greatly increase the processing speed.

The pneumatic components are all imported components, the air circuit design is advanced and reliable, and can be equipped with three different cutting gases and can be freely selected. The whole pneumatic system adopts high pressure resistant design. When using nitrogen as auxiliary gas to cut metal materials, the nitrogen pressure can reach 3Mpa.

In order to ensure the stability of the pneumatic system, the imported components are used to greatly improve the stability of the pneumatic system. The principle of laser cutting is to use a focused fiber laser for cutting. Through optical fiber transmission, the degree of flexibility is high, the speed is fast, the number of fault points is small, the maintenance cost is low, the maintenance is convenient, and the photoelectric conversion rate is high. Mainly used in metal crafts, hardware products, precision machinery, auto parts, sheet metal processing and other industries.

Note: The size of the selected laser power is determined based on the material cut thickness.

Chapter 2 Safety Instructions and Precautions

2.1 Security Management Notice

Before operating the machine and performing routine maintenance, the operator must read this section carefully to understand the machine safety precautions and requirements and to comply with the relevant safety precautions.

1 Designate the security administrator to determine the scope of their duties and provide training in laser operations operators for safe operation and safety protection.

2, specify the laser safety management area, set warning signs at the entrance and exit of the management area, including: laser processing machine power, laser type, prohibiting outsiders from entering, pay attention to protect the eyes and the name of the safety management personnel.

3 The operator of the laser processing machine must be specially trained to reach a certain level and put into use with the consent of the safety administrator.

4 The main harm of laser to the human body is the eyes and skin. Any part of the body exposed to the laser can cause burns. Avoid placing any part of your body in the working light path of the laser device to avoid injury due to misuse.

2.2 laser safety protection

The operator of the laser cutting machine or the person who approaches the laser during laser operation should wear a laser protective lens with a wavelength of 1064 μm . In the area where the protective lens is worn, there must be good indoor illumination to ensure smooth operation of the operator.

Do not place any part of the body under the beam, otherwise it will cause burns or even life-threatening to the human body. No one should, at any time, be facing the direction in which the laser (including the red indicator light) is ejected.

When the shutter is opened, the human and non-working objects are prohibited from being exposed to the laser. It is strictly forbidden for the operator to leave during the operation of the machine. If an abnormality occurs during the use of the device, immediately press the emergency stop switch.

The cooling water temperature and the auxiliary gas pressure should be checked frequently during use. Operate the equipment with the operation permit and observe the safety operation procedures. It is strictly forbidden for the equipment staff to operate.

The laser of this equipment is a Class IV laser product. The fiber laser is invisible. The beam emitted by the lens, the reflection of the lens and the diffuse reflection of the light may cause damage to the human body (especially the eye). The personnel present should pay attention to the protection and prevent the fire from happening. .

Exhaust gas generated during laser cutting is harmful to the operator. Please ensure that the equipment's dust suction device is operating normally and the working site is ventilated.

2.3 Electrical Safety Precautions

Do not touch any switches with wet hands to avoid electric shock. All parts of the machine with warning signs indicate that there are high-voltage electrical or electrical components in these areas. Operators should be careful when approaching these parts or repairing to avoid electric shock. Such as: protective cover of the position of the servo motor, equipment transformer, electrical cabinet door, etc.

Read the machine manual and electrical schematic carefully and thoroughly to familiarize yourself with the functions and corresponding key operation methods.

It is forbidden to change the set machine parameters privately. If changes are required, they must be trained by an equipment manufacturer and approved by an authorized professional, and the values of the parameters before the change must be recorded so that the original state can be restored if necessary.

Lasers for processing, generally with a supply voltage of several thousand volts to tens of thousands of volts, should protect against the danger of X-ray damage from the high-voltage and high-voltage electrons of the laser.

Do not touch live components in the electrical cabinet during power-on, such as numerical control devices, servos, transformers, fans, etc.

Warning!

After power off, you must wait for more than 5 minutes before touching the terminal. A high voltage is left between the power line terminals for a period of time after the power is turned off. To avoid electric shock, do not touch it immediately.

Oxygen is often used in laser cutting, and sparks are splashed during cutting. Oxygen is a danger of fire. Therefore, there should be no flammable or explosive materials in the work area, and appropriate preventive facilities, such as fire extinguishers.

2.4 Preparation materials before installation

item	name	Specification	unit	Quantity	Note
1	Deionized water / distilled water / purified water	18 liters / barrel	liter	4	1. 500W-1500W: 40 liters 2. 2000W-3000W: 70 liters 3. 4000W: 120 liters 4:6000W: 160 liters
2	Nitrogen	Nitrogen purity $\geq 99.9\%$	Batch	1	Not less than 4 bottles
3	oxygen	Oxygen purity $\geq 99.9\%$	Batch	1	Not less than 2 bottles
4	air switch	4P/AC220V/63A	piece	1	Machine mains power
5	air switch	3P/AC220V/50A	piece	1	Chiller
6	air switch	3P/AC220V/32A	piece	1	Exhaust fan
7	Power Supply	20KVA~100KVA AC220V	set	1	Laser cutting machine power input ①、500W-750W:20KVA ②、1000W-1500W:30KVA ③、2000W-3000W: 50KVA ④、4000W: 80KVA. ⑤、6000W: 100KVA.
8	Air compressor	Need to remove oil and remove water	set	1	Output pressure $\geq 2\text{Mpa}$
9	Dryer	High precision oil water separator	set	1	
10	Ground pin	Copper or galvanized, length $> 1.5\text{ m}$, diameter $> 15\text{ mm}$	piece	3	The machine host needs 2 pieces; Laser source need 1 piece.
11	Vaporizer	meter / minute, Withstand voltage 4.0	piece	2	Used in combination with liquid nitrogen and liquid

		MPA			oxygen
12	Nitrogen pressure reducing valve (used abroad)		piece	1	Enter: $\geq 15\text{MPa}$, Output: 0.2~3.0MPa.
13	Oxygen pressure reducing valve (used abroad)		piece	1	Enter: $\geq 15\text{MPa}$, Output: 0.05~1.5MPa.

Note: All air switches above are recommended without leakage protection. If the leakage protection function is provided, the rated leakage protection current shall not be less than 300mA, and it is recommended to be 500mA or more. A rated leakage protection current of less than 300 mA may cause leakage protection to trip.

2.5 Workshop size preparation before installation

Figure VLF 6060 size chart

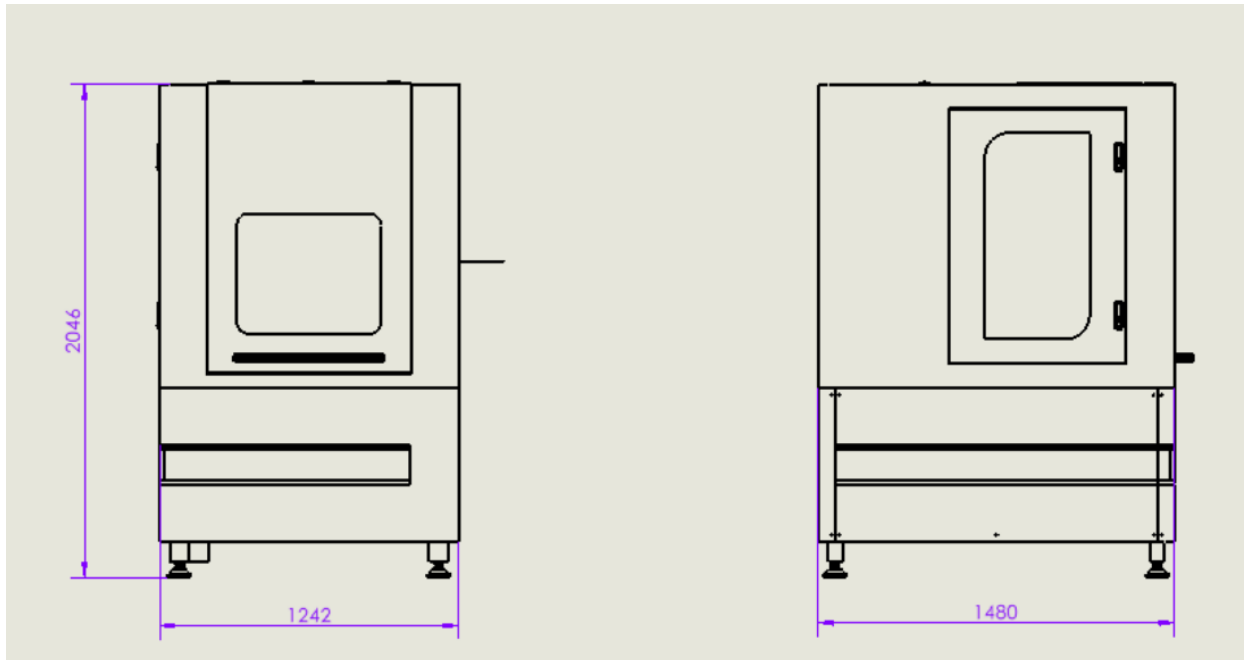

Note: The ground level is not more than $\pm 10\text{mm}$ and can withstand more than 6 tons of heavy objects. The thickness of the concrete on the entire installation surface of the bed and the table legs shall not be less than 200mm, the compressive strength shall not be less than 30N/mm^2 , and the load shall be greater than 30KN/m^2 . Installation of the foundation requires no large vibrations around the ground. If so, you need to drill a shock ditch.

According to the machine floor size map, the steel plate is embedded at the ground level. The thickness of the steel plate is 20mm or more, and the size is $250\text{mm} \times 250\text{mm}$.

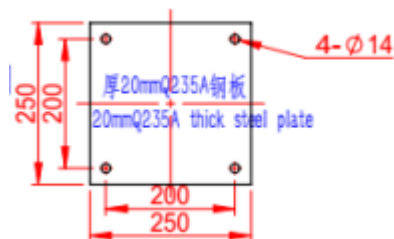

2.6 Machine's use condition

- Power supply specifications: three-phase five-wire system 220V 60hz;
 - Quality: Three-phase unbalance $< 2.5\%$, line voltage fluctuation $< 5\%$. Single phase $220\text{V} \pm 5\%$. The machine must be equipped with a regulated power supply. The regulated power supply can ensure the stability of the input voltage of the machine, so that the entire machine tool and laser work in a relatively good state. Air compressors and fans should not pass through the regulated power supply to prevent the instantaneous high current changes of high-power devices from interfering with the power output of the laser.
 - Grounding requirements: Set the grounding pin to the grounding wire 1 meter away from the machine. The grounding resistance should be less than 4 ohms. The total number of ground needles is ≥ 3 , the material is pure copper or galvanized, the ground needle diameter is $\geq 15\text{mm}$, and the length is $\geq 1.5\text{m}$.
- Environmental requirements: a site with good ventilation, no dust, no corrosion, no pollution, no water leakage. The recommended ambient temperature is between $+5^\circ\text{C}$ and $+33^\circ\text{C}$.

Note: Avoid thermal deformation on one side of direct sunlight and one side of the wind (for example, louvers can be installed when installing in the window position to avoid these situations).

- Water-cooling system: The water-cooling machine is equipped with water for

circulating flow. It is used to cool special equipment such as lasers and cutting heads. The circulating water needs to use high-quality pure water or distilled water. It is strictly forbidden to use mineral water. When the ambient temperature is $< 0^{\circ}\text{C}$, the cooling water should be replaced with antifreeze before the ambient temperature $< 0^{\circ}\text{C}$ to avoid freezing damage to the equipment, pay special attention!

- The distance between the left and rear sides of the machine tool should be above 1.2M; the laser and water cooling machine should be above 1.0M from the wall. The control unit, servo unit and display and control panel are the core components of the machine tool, which have certain requirements on the environment, and should avoid electromagnetic interference from the machine tool, such as arc welding and electric discharge machine, so as not to affect the normal operation of the machine tool.

- Fire safety: In order to prevent the occurrence of fire, the processing site should be equipped with appropriate fire extinguishers and reserve certain fire exits.

- Requirements for gas standards; 1 Oxygen; if liquid oxygen is used, a vaporizer must be added to raise the liquid to a normal temperature. High pressure liquid bottle withstand pressure 4.5MPA, vaporizer withstand pressure 4.5MPA, flow rate: 1.0 cubic meters / minute, output pressure: 2.0MPA.

2.Nitrogen: If liquid nitrogen is used, a vaporizer must be added to raise the liquid to a normal temperature. High pressure liquid bottle withstand pressure 4.5MPA, vaporizer withstand pressure 4.5MPA, flow rate: 1.0 cubic meters / minute, output pressure: 3.0MPA.

3.Air: If high-pressure air is used to cut the board, pure and dry high-pressure air (maximum air pressure 3.0MPA) is required.

Precautions:

Never use the gas completely. When the cylinder is returned, the residual pressure in the bottle must be at least one atmosphere above the air pressure. When the cutting oxygen gas pressure is low, the laser cutting machine control system will alarm. Please change your gas in time.

2.7 Unloading requirements

The equipment is transported to the final installation site with a truck, which must be prepared and implemented by the user. The route of the machine to the installation site must be declared in time before delivery. In particular, it is

necessary to check the size of the door opening, the height of the pillar, the height of the cable holder, and whether the armor can be used for the road surface. The scale of the machine marked on the drawing must be taken into consideration during transportation!

1 Auxiliary and handling tools

The following items must be prepared by the user:

- Truck cranes for machine tools, lasers and attachments. It is recommended to have a hydraulic crane with a gravity of at least 10t; if a larger boom is required depending on local conditions, the truck crane must have a greater lifting capacity.
- Forklift (capacity 10 t).
 - Bridge crane: bearing capacity 10t
- armored rollers (1 steerable, 2 solid).
- At least 2 hydraulic jacks with a lifting force of at least 5 t (minimum height setting: 30 mm).
- Crowbar (1 m) and extensions.

2 What the user should do:

- All transportation work must be carried out in accordance with the relevant transportation rules.
- Do not allow the machine to be placed on the floor without a bottom plate, otherwise the bottom of each component may be damaged! The bottom plate of the machine tool must be less than 100 mm from the ground, and then move the machine to the installation site. This distance must also be guaranteed during the movement.
- The foundation conditions of the installation site must meet the requirements in the installation conditions. The work of slitting, punching, etc. on the floor of the installation location must be prepared by the user according to the basic plan before the machine arrives.
- The machine tool uses a truck crane with corresponding gravity to unload the machine from the truck.
- Laser source, refrigeration units, suction units, etc. can be transported directly from the truck to the machine installation site using a forklift.
- Carry the machine from the outside to the factory on the armored rollers.
- Use a bridge crane with considerable capacity in the plant or continue to carry the machine to the installation site on the armored rollers.

2.8 Precautions for unpacking

The chiller, laser, power distribution cabinet and other accessories of the fiber laser cutting machine are packed in polyethylene foam and wooden boxes. For other parts, the packaging is wrapped with polyethylene foam and protective film on the outside to protect them. The external parts of the laser cutter are damaged by external objects, and the foam is removed when it is removed.

2.9 Checking the content

1. After opening the package, please confirm whether it is the product you purchased;
2. Check the product for damage during transportation;
3. Confirm that all components are complete and damaged;
4. If there is any product type mismatch, lack of accessories or shipping damage, please contact our company in time;

2.10 Engineers install and training services

- Check, inventory, and clean the machine for scratches, rust, accessories and tools.
 - Installation of main components: equipment level adjustment. Water cooler installation. Fiber optic installation. Installation of laser head. Gas connection. Fan installation.
 - Machine installation: display installation. Connection of the whole machine and electrical cabinet. Installation of sheet metal parts.
 - Power-on test: Check before power-on External voltage check Origin limit switch test Each axis moves and returns to the machine origin Water-cooled machine is energized Fiber-optic power supply Fan power-on
 - Trial cutting: feeding opening, air opening, checking red light, nozzle dimming, material calibration and automatic edge finding, graphic processing, parameter setting, cutting.
 - Functions and connection methods of key components: connection between laser and water cooler and cutting head. Connection between fiber optic and board. Connection of gas and equipment. Connection of control cabinet and external line. Installation of control card wireless controller and driver the way.
 - Installation and introduction of the cutting head: Structure description of the cutting head Focusing instructions Daily maintenance.
 - Introduction of the console button: emergency stop switch Key switch Gas button Enable switch

- Switching machine steps: the booting sequence and shutdown sequence of the whole machine.
- Sheet cutting operation steps: control software operation steps
- Equipment and personal safety: safety introduction and precautions for operators
- Guide customers to practice: Allowing customers to operate independently is the focus of this training.
- Cutting process debugging: cutting of conventional materials and different materials using different nozzle types and focus and cutting parameters.

Chapter 3 Instructions for Using the Machine

3.1 switch machine steps

- Open the main switch → Computer → Software → Gas → Water Cooler → Fiber Optic → Software Emergency Stop
- Check the whole equipment before power-on: mainly check the trajectory of each moving part of the machine and whether there is any foreign object on the worktable.
- External device startup:

Start the total power supply equipment: total power switch, voltage regulator equipment.

The chiller starts: check whether the status is normal, whether the water supply is normal, and whether there is water leakage in the waterway. Wait for the water temperature to rise to 18 degrees. The water inlet and outlet of the water cooler are respectively connected to the water outlet and the water inlet of the fiber optic; The two water pipes for cooling the laser head can be connected to other water inlets and outlets of the water cooler. The two water pipes that are cooled by the laser head are connected to the two fiber outlet pipes and are respectively connected to the fiber head and the cutting head.

Start the host computer and open the software back to the remote point.

The laser starts to check for abnormality.

Start the auxiliary gas, such as an air compressor, open the required air supply valve, and check whether the status of each filter device and each pressure gauge in the air circuit is normal.

- Shutdown step: return to the original point → turn off the gas discharge pipeline gas → turn off the water cooler → turn off the computer operating system → turn off the fiber → turn off the software emergency stop → turn off the main switch

The start-up procedure of the laser cutting machine must be strictly observed. Start the laser in strict accordance with the laser start-up procedure.

3.2 software operation process



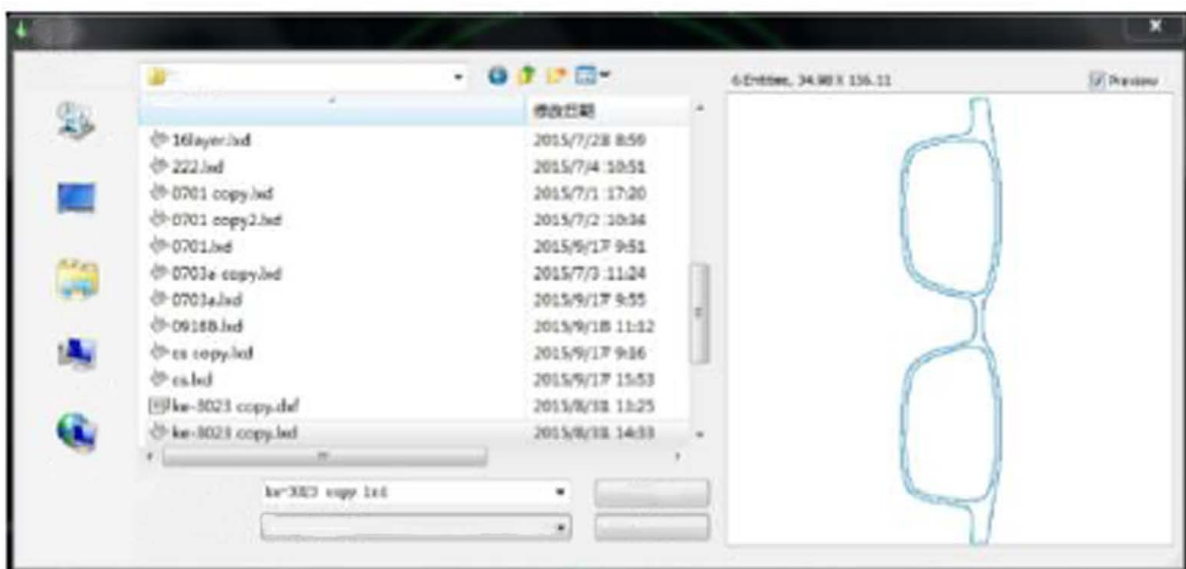

Making graphic-data--importing-graphics--preprocessing--process-setting--knife planning -pre-processing inspection--machining control

1. Import the graphic; click the open file "  " button in the quick launch bar in the upper left corner of the interface to pop up the Open File dialog box, select the one you need. Open the graphic. The right side of the Open File dialog provides a quick preview window to help you quickly find the files you need.





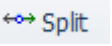

If you want to draw a part in the field with the CypCut software, click the New button and use the left. You can draw the buttons on the side drawing toolbar, see the related chapters.

2. Pre-processing; while importing graphics, CypCut will automatically remove very small graphics, remove repetitive lines, merge connected lines, auto-smooth, sort and

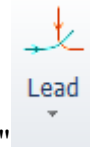
break up. In general, you can start setting process parameters without other processing. . If the automatic process does not meet your requirements, you can open the menu "File" - "User Parameters" to configure. In general, the software believes that the graphics to be processed should be closed graphics. If the file you open contains unclosed graphics, the software may prompt you and display it in red. However, this feature may be turned off to view the unclosed drawing on the drawing board. Shape, you can click on the common menu bar "Show" button  " and  " buttons to highlight unclosed graphics; You can also select all unclosed graphics by clicking the large button "Select" on the leftmost side of the toolbar and then clicking "Select Unclosed Graphics". If in some cases you need to manually split the graph, click on the  " button under the "Optimize" button under the common menu bar. Button, then click the mouse where you want to split. Need to merge graphics, select the graphics you want to merge, then click  " button.

3. Process settings; in this step you may use most of the functions in the "Process Settings" column under the common menu bar, including setting introduction

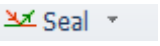
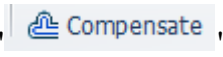

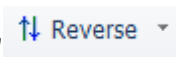
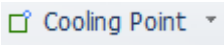
Lead lines, set compensation, etc. Large size button  " can be used to set the lead-in lead, button  "Used to set over cut, notch or seal parameters; button  " for kerf compensation; button  " for Insert a small segment of the graph that is not cut; the button  " reverses the single graph; the button  " is used in the graph

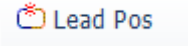
Set the cooling point in the shape. Click the  " button, then click on the place you want to set as the starting point of the graph, you can change

The starting point of the graph, if you click outside the graph and then click on the graph, you can draw a drop line by hand. As a quick start tutorial, you can press Ctrl+A to select all the graphics, then click the "Leader" button, set the parameters of the leader, and then click OK. The software will automatically find the appropriate position according to your settings. line. Click the small triangle below the "Leader" and select "Check Import and Export" to check the legality of the lead-in line. Select "Differentiate Internal and External Mode" to automatically optimize the lead

according to the internal and external modes.

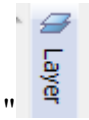

Detailed cutting process parameters can be set by clicking the "Layer" button on the right toolbar. The Layer Parameter Settings dialog contains almost all the parameters related to the cutting effect.

4. Tool path planning; In this step, the graphics are sorted as needed. Click the sort

“” button under the common or layout menu bar to sort automatically. Click the small triangle below the sort button to select the sorting method. You can control whether the automatic sorting process is allowed to change the direction of the graph and whether the inner and outer modes are automatically distinguished.

If the automatic sorting does not meet the requirements, you can click the “” button on the left toolbar to enter the manual sort mode. The order of processing is set by clicking the graph in order with the mouse. By holding down the mouse and drawing a line from one drawing to another, you can specify the order between the two figures.

Select several images that have been sorted, and then click the group “” button under the common or layout menu bar to fix their order. After that, automatic sorting and manual sorting will no longer affect the group. "Internal graphics, "groups" will always be a whole. You can also sort the graphs inside the group by selecting a “group” and then right-clicking to select the sort within the group.

5. Pre-processing inspection; The machining path can be checked before the actual cutting. Click each alignment button to align the graphics accordingly. Drag the interactive preview progress bar (under the drawing menu bar) as shown below to quickly view the graphics processing order. Click the interactive preview button to view the graphics processing one by one. order.

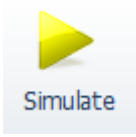
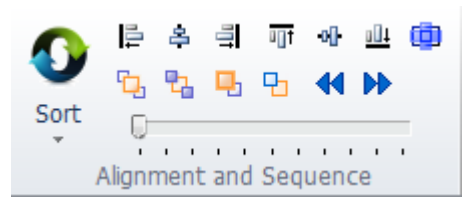

The simulation can be performed by clicking the “Simulate” button on the “Console”, and the speed of the analog machining can be adjusted by the “Analog

Speed” function on the “  ” tab.

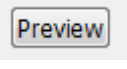
6. Actual machining; please note that this step must be run on the actual machine and must be supported by the dongle and control card. Before the formal processing, you need to match the graphics on the screen with the machine tool, click on the left side of the "Control Panel" arrow button. “  ”The button shows the relative positional relationship between the graphic to be machined and the machine's web on the screen. Corresponding

The system is calculated by matching the stop mark on the screen with the position of the laser head on the machine. The figure below shows several coordinate markers that are common on the screen. When you click Preview, the Stops will pan to the Laser Head Position, which visually shifts the image as a whole.

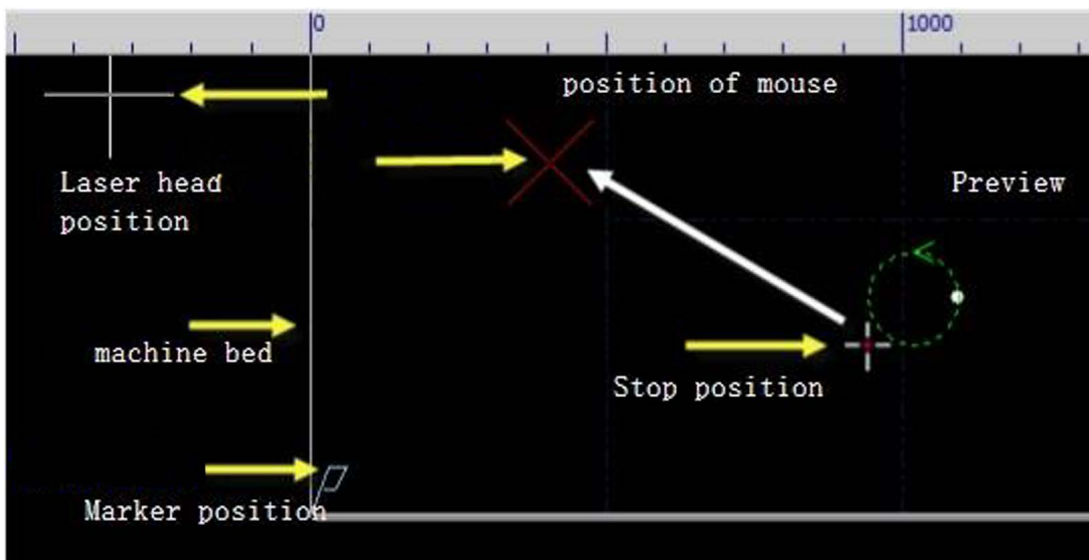

If the “laser head position” indicated by the red cross cursor does not match the laser head position on the actual machine, please check if the machine origin position is correct, and correct it by “CNC”->“Return to origin”. If the preview finds that all or part of the graphic is outside the machine format, it means that the materials may be exceeded the machining bed.

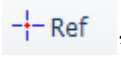
You can change the relative relationship between the graph and the stop by clicking the “ Dock  ” button under the common menu bar. For example, the laser head is located

For the lower left corner of the workpiece to be machined, set the stop point to the lower left corner, and so on.

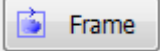
After checking the screen, click the “ Walking border  ” button on the “Control system” and the software will control the cutting head to be added.

The outer frame of the work pattern is taken one turn, so you can check if the machining position is correct. It is also possible to check the machining operation in a more detailed manner by clicking the “Empty walk  ” button to complete the operation of the graphic to be processed without opening the laser.

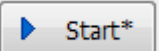
Finally, click the “start  ” button to start the formal processing.

Click the “ stop  ” button to pause the machining. During the pause, you can manually control the laser head lift, manually switch the laser, gas, etc.;

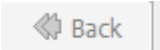
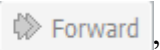
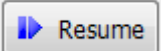
The “Back and forward “   ” button is traced along the machining path; click the “ go on  ” button to continue machining.

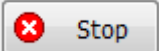

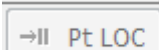
Click the “stop  ” button to abort the machining. According to your settings, the laser head can automatically return to the corresponding point. only

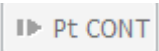
If you have not changed the shape of the graphic or started a new round of processing, click the "Breakpoint positioning  ." button and the software will allow you to locate it.

Where it stops, click the “ Breakpoint continues  ” button to continue processing from where it left off.

3.3 operation of capacitor heightener

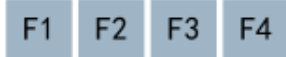
- The key:

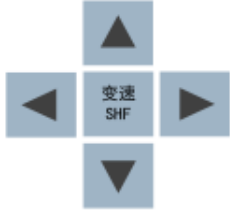
Keyboard	Function
Functional key	 Achieve the functions prompted by the interface.
Number key Decimal point Backspace key	 : Used for digital input, and mainly for parameter input
Arrow key	 : Used for switching cursor and inching follower, and the key of “SHF” can switch the jog speed.

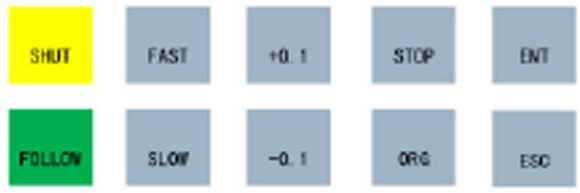
Control key	 <p> <SHUT>: The cutting head will automatically rise to the stop position while shutting the follower. <FOLLOW>: Open the following function. <FAST> and <SLOW>: Used for adjusting the following gain level. <+0.1> and <-0.1>: Used for adjusting the following height. <STOP>: Immediately stop all movements. <ORG>: Immediately implement the movement to go back to the origin and correct mechanical coordinates. <ENT>: Confirm the current operation. <ESC>: Cancel the operation and go back. </p>
-------------	----------------------------------------------------------------------------------------------------------------------------------------------------------------------------------------------------------------------------------------------------------------------------------------------------------------------------------------------------------------------------------------------------------------------------------------------------------------------------------------------------------------------------------------------------------------------------------------------------------------------------------------------------------------------------------------------------------------------------------------------------------------------------------------------------------------------------------------------------------------------------------------------------------------------------------------------------------

After the system power-on initialization is completed, it will automatically enter the [Main Interface]. As shown below:

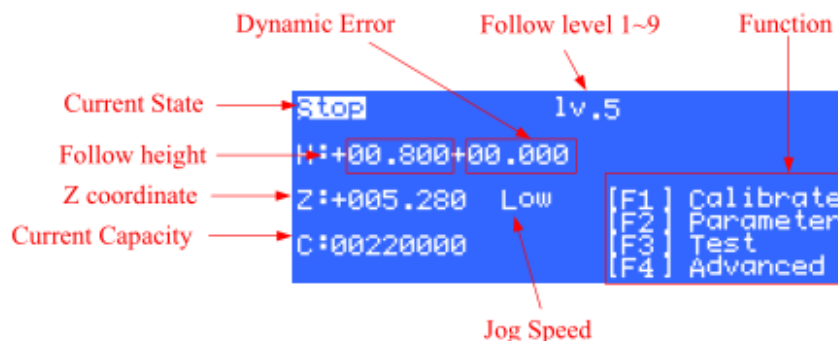

The display functions on the main interface include: Current status: Displays the motion status of the current slave system.

There are several types of sports:

Stop: The Z axis is at rest.

B. Slow stop: After receiving the stop command in the motion state, there will be a short slow transition state. After completely stopping, the status becomes "stop"

C. In the air movement: the upward movement in the machining is the air movement of the Z axis.

D. Following: When piercing or cutting, the floating head is in the state of following the board being cut.

E. Reset: Return to the Z axis mechanical origin.

F. Jog: Manually jog the Z axis.

G. Back to stop: the process of closing and lifting to the docking position.

Follow-up gain level Lv: Follow-up gain level from 1~30, default 17 levels. The larger the number of stages, the smaller the average error of the follow-up, the faster the follow-up action, and the stronger the ability to climb the slope. However, if the gain is too strong, the system will generate self-oscillation. This parameter can be obtained by automatic adjustment.

Set following height: Press <Follow> <Follow> on the main interface to adjust the actual following height in 0.1mm steps. Press <Follow On> <Follow Off> to control whether or not to follow. After the switch is closed, the axis will automatically be lifted to the docking coordinates (the default is Z= 0, press <F2> to enter the parameter interface, you can also modify the docking coordinates). In addition, in the Ethernet control mode, the following height is controlled by CypCut software. Settings. Dynamic error: In the following state, this value reflects the real-time error during follow-up motion.

Distance between the floating head and the board surface H: Within the



6216 S SANDHILL RD LAS VEGAS, NV 89120 TEL 702-802-3100

capacitance measurement range (calibration range), the distance between the floating head and the board surface = "set following height" + "dynamic error". When the measurement range is exceeded, the "set following height" + "dynamic error" is always equal to the calibration range. Current Z-axis coordinate: After homing, the Z-axis establishes the mechanical coordinate system. The downward motion coordinates increase. Current Capacitance Value C: The principle of system sampling is to obtain the distance by measuring the capacitance between the floating head and the plate. The closer the floating head is to the plate, the larger the capacitance value. When the floating head hits the plate, the capacitance will change to zero. Capacitance change value: This value is the difference between the current body capacitance value and the recorded body capacitance after the last floating head calibration. The square brackets indicate that the real-time calibration function is enabled, and the parentheses indicate that the function is not enabled. The real-time calibration function is described in 2.5.8 Advanced Parameters.

Z-axis jog speed: L jog low speed, H jog high speed. Press the <Shift> button to switch the jog speed position. Press the <↑><↓> button to perform the jog.

1 Main interface hidden function Button Function <3> View the follow-up parameters (requires the manufacturer password to modify the parameters). <4> Follow the real-time error oscilloscope. <5> The capacitor monitors the oscilloscope in real time. <6> Capacitance calibration curve oscilloscope. <7> Record the current capacitance and use it to observe the historical change data of the capacitor. <9> Turns on the follow-up mode of the off-board cutting. <0> Set the current Z axis coordinate to 0.

Calibration interface

In the main interface, press <F1> to enter the [calibration interface]. As shown below

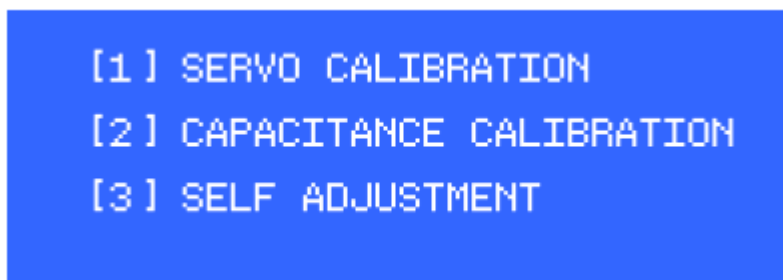

When using the BCS100 for the first time, you must first perform servo calibration, then perform floating head calibration, and then make automatic adjustments. In subsequent use, if the capacitance changes due to temperature drift and other reasons, only need to do floating head calibration, servo calibration and automatic adjustment can be done.

1 Servo calibration The purpose of servo calibration is to eliminate the zero drift of the servo motor. Press <1> to enter the [Servo Calibration] screen. As shown

below:

```

Please confirm the Mechanical
parameter is right.
Jog to the middle of Z axis.

Z:+005.280 Low

[ENT]BEGIN
  
```

Due to the servo calibration, the motor will oscillate back and forth in small amplitudes. Therefore, you need to jog to the middle of the stroke to prevent the stroke from exceeding the stroke range. Then press <ENT> to start the calibration.

```

Calibrating servo...
Calibrate successful
Offset: +01.200mm/s

[ENT]SAVE
  
```

After the system is automatically calibrated, return to the previous interface. If the servo zero drift value is incorrectly calibrated before, press <F4> to clear the clear zero drift value interface, as shown in the figure below:

```

Set Offset to 0?

[ENT]CONFIRM
[ESC]CANCEL
  
```

After entering, press <ENT> to confirm the zero drift value, and return to the previous interface after completion.

2 Floating head calibration The purpose of floating head calibration is to measure the correspondence between capacitance and position between the floating head and the plate. Press <2> to enter the [Floating Head Calibration] screen. As shown below

```

Please jog to approach the board
Keep board static,no vibration.

Z:+001.11 Low
C:00320000

[F4] SET
[ENT]START
  
```

Press the <F4> key to set the calibration parameters.

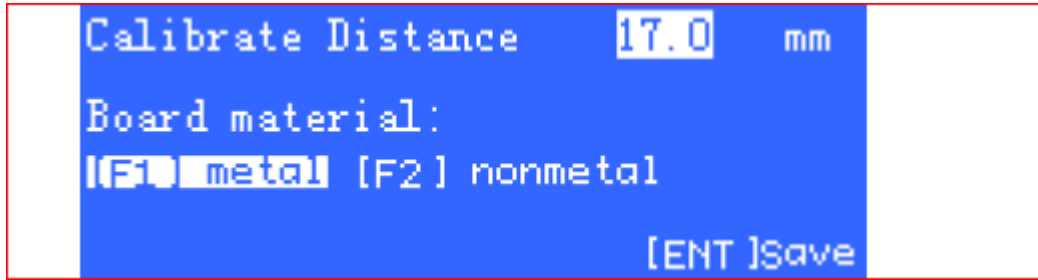

Parameter name Meaning

Calibration range The distance to be lifted up and the corresponding data is recorded. The default is 25mm. **Tracking Object Sets** the material of the tracking object. Press <ENT> to save the parameters and return to the previous interface. Before calibrating, first move the floating head to the surface of the board (about 1~5mm from the board surface), and keep the board surface still and do not vibrate. Press <ENT> again to start calibration.

The calibration process is done automatically, which takes about a dozen seconds. During the calibration process, the user can press the “Stop” button to force the calibration to end. When the calibration is completed, there are 2 indicators, each of which has “excellent”, “good”, “medium” and “poor”. Four levels.

The floating head calibration process is briefly divided into the following steps: (1). The floating head slowly moves downward to detect the touch panel. (2). After hitting the board, move up a distance to detect the stability of the sensor. (3). The floating head moves slowly to detect the touch panel for the second time. (4). After hitting the board, move the set calibration distance upwards to detect the smoothness and characteristic curve of the sensor. If the above steps are not completed, or the calibration process is terminated abnormally, there may be a problem with the hardware or the cable. A simple way to check if the hardware or connection is normal is to use a metal object to slowly approach the nozzle to see if the capacitance will change. If the capacitance becomes larger until the metal contacts the nozzle and becomes 0, it means that the hardware and connection are normal, and the calibration can be calibrated. conditions of. The significance of the calibration results is as follows:

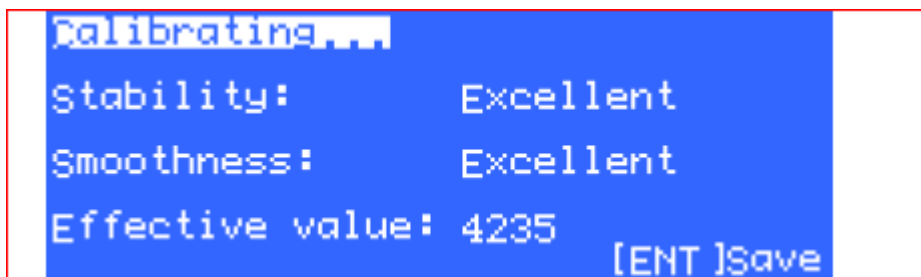

Reflects the static characteristics of the capacitor. If the indicator is not ideal, it

may be plate vibration or external interference. Smoothness: Reflects the dynamics of the capacitance change during calibration. The indicators calibrated by the above two parameters need to be at least “medium”, otherwise the system may not work properly. The ideal situation for these two indicators is “excellent” or “good”. RMS: The value of the capacitor from 0.5mm to infinity. Reflects the measurement range of the nozzle sensing. The larger the measurement range, the better the accuracy and stability of tracking. When you press <ENT> to save the settings, the height-capacitance curve is displayed. The normal curve should be smooth, as shown below:



If the curve is not smooth, there are undulations or burrs, indicating that the result is not ideal and needs to be recalibrated. If the result after repeated calibration is still not satisfactory, the user needs to re-check the hardware installation and connection of the system. In addition, you can also view the calibration curve by pressing <6> on the main interface. Floating head calibration, if the calibration fails, various alarms will appear, as listed below: Calibration alarm name meaning.

a touch panel detection timeout

At the time of calibration, the touch panel was not detected for a long time. When this alarm occurs, first confirm the floating head connection before calibration. Near board (usually within 5mm), and secondly, confirm that the sensor is connected and working properly. When the cutting head is close to metal, the capacitance should change significantly.

Leave board detection timeout

If the first step of the calibration, the nozzle does not touch the board surface, directly lifts up, and shows that the departure board detects timeout, then the system may think that the nozzle is always in the collision state. First, confirm that the sensor is connected and working properly.

The sampling timeout has been completed but not enough data has been collected. Please recalibrate. Always for the board status See the "Leave board detection timeout" alarm.

d standard timing capacitance change abnormal

When the floating head is close to the board surface, the capacitance does not gradually increase according to the law. Please start the calibration by moving the floating head to within 5mm of the board surface. Or refer to "Touchpad Detection Timeout"

3 Auto Adjustment Press <3> to enter the [Auto Adjustment] interface (there is

no automatic adjustment function in 3D mode), as shown below:

```
1.Please confirm capacitance,  
servo calibration and origin have  
been done.  
  
2.Please confirm that a board  
below can be followed.  
  
[ENT ]BEGIN
```

a Before automatic adjustment, you need to ensure:

I have done servo calibration.

Once I have returned to the origin, the mechanical coordinates of the Z axis are correct.

I have done floating head calibration and can follow it normally.

There is a board just below the floating head to follow.

The process of automatic adjustment is to fine-tune the position near the position and automatically optimize the internal parameters.

After optimization, as shown below

```
Adjust finished!  
Follow Down Gain Lv: 20->19  
  
[ENT ]SAVE
```

Press <ENT> to save the parameters. The parameters of the automatic adjustment have the following meanings:

Follow-up gain level

The follow-up gain level is from 1 to 30, and the default is 17 levels. The larger the number of stages, the faster the following follow-up actions. If the gain is too large, it will cause following jitter. This parameter is automatically set after automatic adjustment (the main interface can also be modified manually).

Network Settings: Press <6> to enter the [Network Settings] interface, as shown below:

```
IP Address   010.001.001.188
Subnet Mask  255.255.255.000
Gateway     010.001.001.001
Net Enable  [F1] on  [F2] off
           [ENT] SAVE
```

When using our company's CypCut laser cutting software, it can easily realize advanced functions such as lifting up any height, frog jump up, segmentation perforation, flight path compensation, etc. through the network. See the description of the CypCut software for details. Users who do not use the CypCut software should turn off the network function, otherwise the boot process will be slower. When connecting to a network, it is recommended to connect the PC and BCS100 through a crossover cable. The IP address of the PC side should be set in the same network segment as the BCS100 (10.1.1.xxx, which cannot be duplicated with the BCS100). The gateway also needs to be set on this network segment, and the last digit is 1, such as 10.1.1.1. As follows:

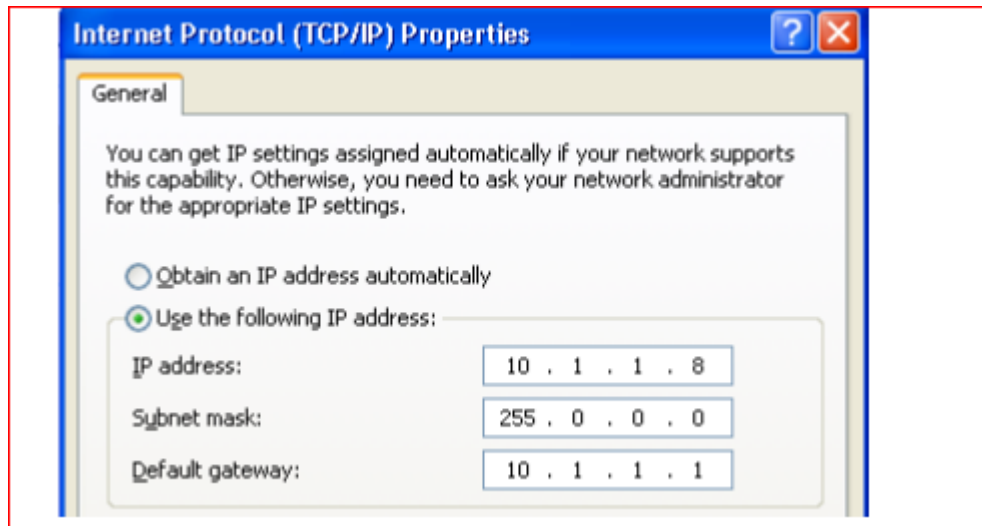

Note: 1. When the computer uses other network devices at the same time, such as IPG fiber laser (network connection method), each network connection must be set to a different network segment. For example, set to: 10.1.2.x, 192.168.1.x. 2. After the computer's network card resets the IP, it must be re-disabled - enable the network card. Make the NIC's IP settings take effect.

3.4 cutting head debugging method and common sense

The debugging of the machine tool needs to be carried out by professionals. It must be strictly implemented in accordance with the relevant regulations. Please understand the performance of the machine and read the relevant random technical data before commissioning. Correct debugging is the basis for ensuring the normal operation of the machine. If there is any ambiguity, please contact our company in time. We will give you a satisfactory answer in the fastest time.

Note: This debugging method includes the debugging method after the machine is powered on.

The fiber laser of the machine is free of optical path debugging, but the operating fiber must be placed strictly in each axis of the towline, and the bending radius must be greater than 200mm. The motion radius is prohibited to be less than 200mm and the fixed radius is less than 100mm.

The fiber is slowly unscrewed from the fiber frame, and the fiber length is required along the machine fiber inlet and each axis towline measurement. Make sure that the water pipe connections are normal and leak-free before starting the machine!

The QBH head must be cleaned before QBH insertion. If there is foreign matter, clean it as follows:

Use a special microscope assembly to observe the QBH head, use special compressed air or professional cleaning agent (ethylene propanol) and cleaning tool fiber special cotton swab, special lens paper to clean the dirt such as QBH head dust! It must be ensured that the QBH head is clean and free of contamination before it can be inserted into the cutting head expansion tube!

Adjust the cutting head lens coaxial and focus, then try to cut! Repeatedly adjust to the best position!

Installation of optical fibers requires that trained personnel install fiber optics, and non-professionals are prohibited from plugging and unplugging QBH!

Note on the use of lenses:

1) The surface of the optical lens such as focusing mirror, protective mirror and QBH head should not be touched directly by hand, which may cause scratch or corrosion of the mirror surface.

2) If there is oil or dust on the mirror surface, it will seriously affect the use of the lens, and the lens should be cleaned in time.

3) It is strictly forbidden to use water, detergent or other cleaning on the surface of the optical lens. The surface of the lens is coated with a special film that can damage the surface of the lens if used.

- 4) Do not place the lens in a dark, damp place, as this will age the lens surface.
- 5) The surface of the lens must be clean, such as dust, dirt, or moisture, which is easy to absorb the laser to cause damage to the lens coating; lightly affects the quality of the laser beam, and the laser beam cannot pass or reflect.
- 6) When installing or replacing the mirror or focusing mirror, do not use too much pressure, otherwise it will cause deformation of the lens and affect the quality of the beam.

How to install or replace optical lenses:

1) Pay attention to the installation of optical lenses: wear clean clothing, use soap or detergent to clean your hands, and wear light and clean white gloves; do not touch any part of the hand with the lens; take the lens from the side of the lens Do not touch the surface of the lens coating directly.

2) When assembling the lens, do not blow the lens against the lens; the lens should be placed on a clean table, and a few lens professional papers should be placed underneath. Care should be taken when taking the lens to prevent bumps and falls, and it is not allowed to exert any force on the coated surface of the lens; the lens holder for mounting the lens should be clean, and clean the dust and dirt in the lens holder with a clean air spray gun. Then, gently place the lens into the lens holder.

3) When the lens is mounted to the lens holder, do not use too much force to fix the lens to avoid deformation of the lens, thus affecting the quality of the beam.

Steps to clean the lens:

Different lens cleaning methods are different. For example: the specific steps of the focusing mirror or collimating mirror are as follows:

1) Steps of cleaning the lens with lens paper: Use a clean air spray gun to blow off the dust on the surface of the lens; use alcohol or lens paper to clean the surface of the lens. The smooth surface of the lens should be placed flat on the surface of the lens. 3 drops of high-purity alcohol or high-purity acetone, slowly pull out the lens paper horizontally in the direction of the operator, repeat the above operation several times until the mirror surface is clean, and it is forbidden to apply pressure on the lens paper to prevent scratches, such as The mirror is dirty. You can fold the lens paper in 2 or 3 times. Repeat the above steps until the mirror is clean. Do not use a dry lens paper to pull directly on the mirror.

2) Steps to clean the lens with a cotton swab: first blow off the dust on the mirror with a spray gun; then use a clean cotton swab to remove the dirt; use a new cotton swab dipped with high-purity alcohol or acetone to move the lens from the center of the lens and scrub the lens. After each week of cleaning, change another clean cotton swab and repeat the above operation until the lens is clean. Take the cleaned lens to a

well-lit area. If the lens is well reflected, the lens is clean. If the reflection is not good, continue to clean the lens; place the lens on the lens holder according to the method described above. It is forbidden to use a used cotton swab for operation.

a) Storage of optical lenses

1) The optical lens is properly stored to keep the quality of the lens intact.

2) The storage environment temperature is 10~30°C. Do not put the lens into the freezer or similar environment. Otherwise, it will condense and frost when it is taken out, which will easily damage the lens. The temperature of the storage environment should not exceed 30 °C, otherwise it will affect the coating on the lens surface.

3) Keep the lens in the box, the lens should be placed in a non-vibrating environment, otherwise it will easily cause deformation of the lens, thus affecting the performance of the lens.

Fiber access and removal methods:

QBH plug insertion operation sequence

1 Remove the dust cover at the top of the chuck

Align the red mark on the plug with the red mark above the QBH chuck and lower it to the bottom.

According to the marking procedure on the QBH collet nut, first turn the nut to the left, then lift it, then turn it to the left to complete the fixed locking procedure.

2 QBH plug removal operation sequence

The QBH plug is removed and installed in the opposite order. The QBH collet nut is rotated to the right, then pressed down, and then rotated right. The plug is in a free state and can be removed from the QBH chuck.

After removing the QBH plug, be sure to cover the dust cover to prevent dust from entering.

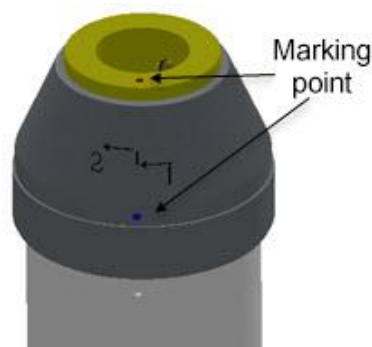

- **Focusing method of focusing mirror:** The focusing mechanism of the focusing mirror adopts the precision screw pulling focusing box to realize Z-axis

focusing, which has good self-locking performance and fine focusing function. Focusing module is electric focusing, focusing lens can be moved vertically according to the type of laser head.

- **The function of nozzle and the adjustment of its center:** The design of nozzle and the condition of jet flow directly affect the quality of cutting, and the manufacturing precision of nozzle is closely related to the quality of cutting. The main functions of the nozzle are: prevent cutting weld stains and other debris bounce up into the cutting head damage focus lens. The nozzle can change the condition of gas exhalation, control the area and size of gas diffusion, and thus affect the cutting quality. Adjust the nozzle to pass the laser through the center of the nozzle by sticking transparent tape on the nozzle first when dimming, pressing the "tap" button on the handle will appear “☉” on the tape. If not in the center of the nozzle by adjusting the two knobs above the cutting head, make the point of light hit at the center of the nozzle.

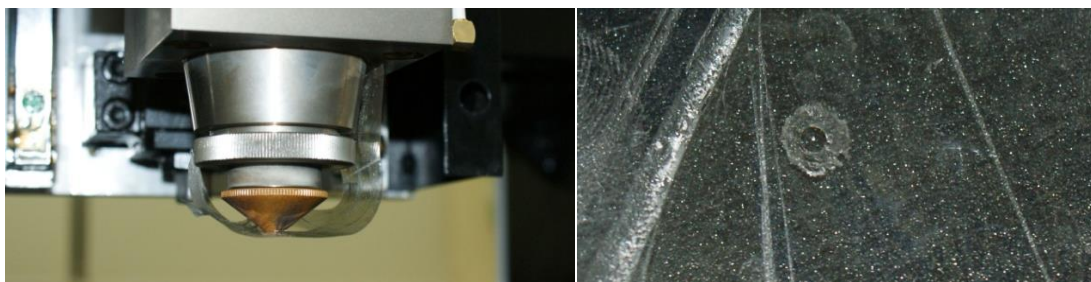
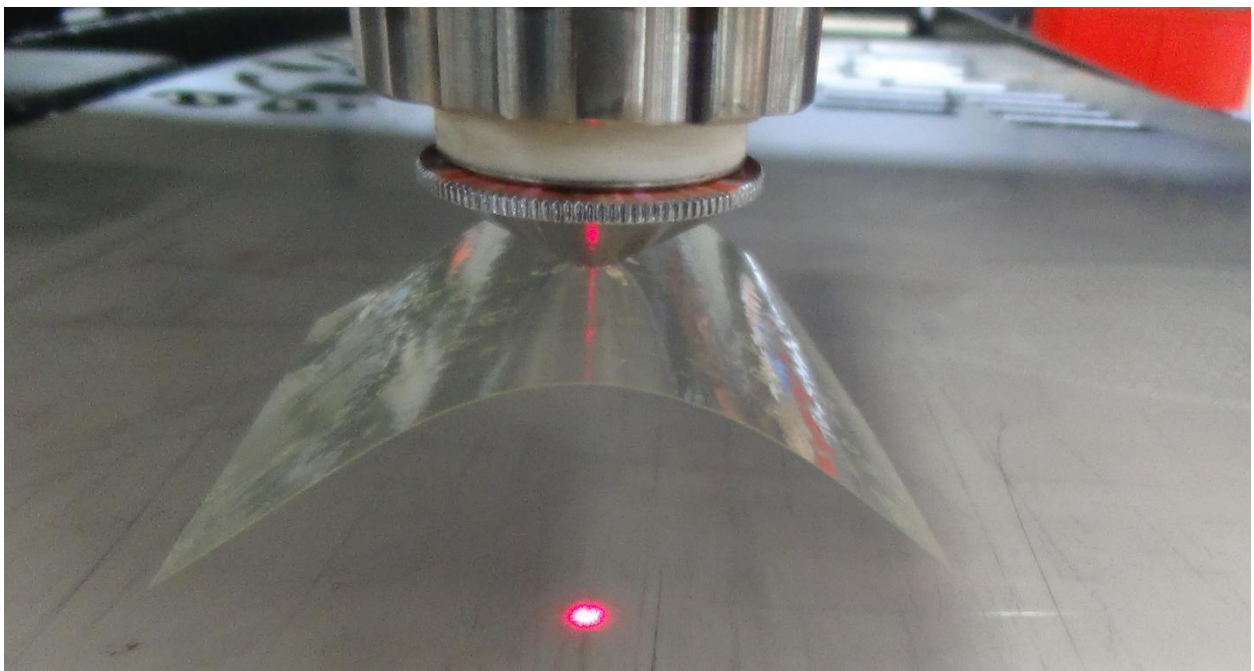

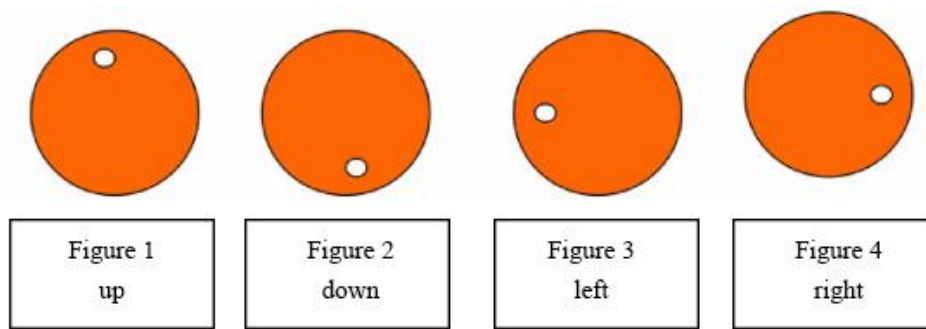

1. Move the nozzle to about the cutting height.
2. Coat the end face of the nozzle with printing mud, and then paste the transparent tape on the end face. Note: in the tool box have transparent tape.
3. Adjust the laser output power by 20W ~ 100W. After laser source light stops, take off the transparent tape and take care not to rotate its relative position. If the position of the nozzle is too different from the laser center, it will not be able to hit the center hole on the transparent tape. Because the laser center is fixed, it is necessary to change the center of the focus mirror by adjusting the adjusting screw on the handle of the lens cavity to make it correspond to the laser center. Repeat the above until the laser hole on the transparent tape coincides with the center of the nozzle, thus confirming that the laser center coincides with the nozzle center.

- **Effect of different axes between the center of the nozzle and the center of the laser on the cutting quality**

- 1) The cutting edge is affected, and when the cutting gas is blowed, the amount of gas is not uniform, so that the cutting edge is easy to appear stain on one side, and other side don't have, or the surrounding quality of the part section is not consistent, and sometimes the cutting section can not be cut normally.
- 2) The quality of the sharp corner is affected. When cutting a workpiece with a sharp angle or a small angle, it is easy to produce a partial melting phenomenon, and when the thick plate is cut, it may not be cut.
- 3) It affects the perforation, is not stable at the time of the perforation, the time is not easy to control, the penetration of the thick plate can cause the over-melting condition, and the penetrating condition is not easy to master, and the perforation effect on the thin plate is small.

In conclusion, the concentricity of the center of the nozzle and the laser is one of the most important factors that cause the quality of the cutting, especially when the workpiece is thicker. Therefore, the concentricity of the center of the nozzle and the laser must be adjusted to achieve a better cutting cross-section.

Note: When the nozzle is deformed or there is a solution stain on the nozzle, the

effect of the nozzle on the cutting quality is as described above. Therefore, the nozzle shall be placed with care, and shall not be damaged to avoid deformation; the surface of the nozzle shall be cleaned in time. The quality of the nozzle has a high precision requirement during manufacture, and the method is required to be correct at the time of installation. If the conditions are to be changed during cutting due to poor quality of the nozzle, the nozzle shall be replaced in time.

- **Selection of nozzle Aperture**

The difference in nozzle aperture is shown in the following 4-1 form

Nozzle aperture	Gas flow rate	Melt removal capacity
Small	Fast	Strength
Big	Slow	Weak

Form 4-1: Table of relationship between Aperture and Auxiliary Gas Velocity

The aperture of the nozzle has $\phi 1.5\text{mm}$ 、 $\phi 2.0\text{mm}$ 、 $\phi 2.5\text{mm}$ 、 $\phi 3.0\text{mm}$ etc. three-dimensional cutting of the general thin plate, using the thickness of 1.2 mm and the thickness of 1.5 mm it's enough. The different between both is :

- 1) Material thickness less than 2mm: use $\phi 1.2\text{mm}$, the cutting surface will be thinner; use $\phi 1.5\text{mm}$, the cutting surface will be thicker.
- 2) Material thickness more than 2mm: because the cutting power is high, the relative heat dissipation time is longer, and the relative cutting time is also increased. With a gas diffusion area of $\phi 1.2\text{mm}$ and a small gas diffusion area, it is less stable in use. With a diameter of $\phi 1.5\text{mm}$, the gas diffusion area is large, and the gas flow rate is slow, so the cutting time is more stable.

In conclusion, the size of the nozzle aperture has a serious effect on the cutting quality and the perforation quality. At present, the laser three-dimensional cutting uses a nozzle with a $\phi 1.2\text{mm}$ and $\phi 1.5\text{mm}$.

The larger the diameter of the nozzle, the more the protection of the opposing lens is, as the spark of the melt at the time of the cutting is splashed, and the probability of the upward impact is large, so that the life of the lens is also shorter.

- **Beam focus adjustment**

In the laser cutting process, the relative position of the focal point of the beam and the surface of the cutting plate has a great influence on the quality of the cutting, and the correct adjustment of the focus position is very important. The laser cutting machine is provided with a height automatic follow adjusting device, and when the height of the plate is changed, the numerical control system can automatically adjust the height of the nozzle and the plate surface to be constant, and the position of the focus is ensured to be stable.

Manual adjustment method: adjust the laser cutting head lower adjustment nut, so that the focus position to meet the cutting needs, provided that the position of zero

focus is found. During the cutting process, the height adjustment of the operator panel can also be manually adjusted according to the situation to change the cutting height slightly. It takes enough experienced operators to adjust the height during the cutting process.

Automatically adjust the focus: equipped with the automatic focus cutting head equipment, can automatically adjust the focus position according to the parameters, the advantage is that it can improve the processing efficiency, can make up for the change of focus position caused by the change of optical path. Can improve the product yield.

- **A method of finding 0- focus**

Place a flat stainless steel plate on the table, draw a straight-line cut height setting of 1 mm, and then set the focus in turn 0. 1.-1-2-3 1 2 3, the focus of the laser is output laser on the stainless steel plate in turn, the burn-out trace is present, and the most thin line of the burn-in is the 0-focus of the laser.

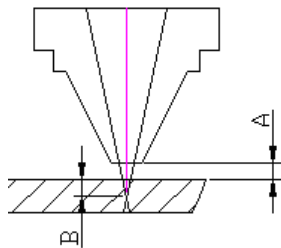

- **Description of the relationship between the position of focus and the cutting material and Section**

The following table lists the laser cutting focus in different positions when cutting different plates, the impact on the perforating and cutting sections of the sheet, and the selection of the focus position when cutting plates of different materials and thickness.

Name and focus location	Cutting material and section characteristic
zero focus: the laser focus is on the upper surface of the cutting work piece	Use in sheet cutting. Focus on the upper surface of the work piece, the upper surface cut smooth, the lower surface is not smooth.
Positive focus: laser focus on cut sheet surface	The use of carbon steel and other materials. The focus is on the surface, so the range of smooth surface is larger, the slotting is wider than the zero focal length, the gas flow rate is larger and the piercing time is longer than the zero focal length.

3.5 Process parameter debugging method

- **Laser cutting principle**

Laser cutting is performed by focusing fiber laser cutting, transmitting through optical fiber, high degree of flexibility, fast speed, less failure point, low maintenance cost, convenient maintenance, high photoelectric conversion rate, and great cost performance advantage in system matching. Mainly used for cutting metal sheets within 20mm. The laser beam is not easily absorbed by the highly reflective material, and the cutting effect on the highly reflective material is not ideal, and the non-metallic material cannot be cut.

- **Main process control of fiber laser cutting**

1 Cutting power: When laser cutting, the choice of laser power has an influence on the cutting quality. The cutting power needs to be determined according to the material of the cutting plate and the thickness of the plate. If the power is too large or too small, a good cutting section cannot be obtained.

When laser cutting, the laser power is too small, which will make it impossible to cut.

When the laser power setting is too large, the entire cutting surface is melted, the slit is too large, and good cutting quality is not obtained.

When the laser power setting is insufficient, cutting cracks are generated, and tumor defects are generated on the cut section.

Proper laser power setting, combined with proper cutting gas and pressure, results in good cut quality without cracking.

2 Cutting speed: The effect of too fast speed on the cutting quality may result in the inability to cut and sparks. Some areas can be cut, but some areas cannot be cut. Causes the entire cutting section to be thicker, but no cracks are produced. Speed is too fast, causing The plate could not be cut off in time, the cut section showed a diagonal stripe road, and the lower part produced a melt, as shown in the right figure.

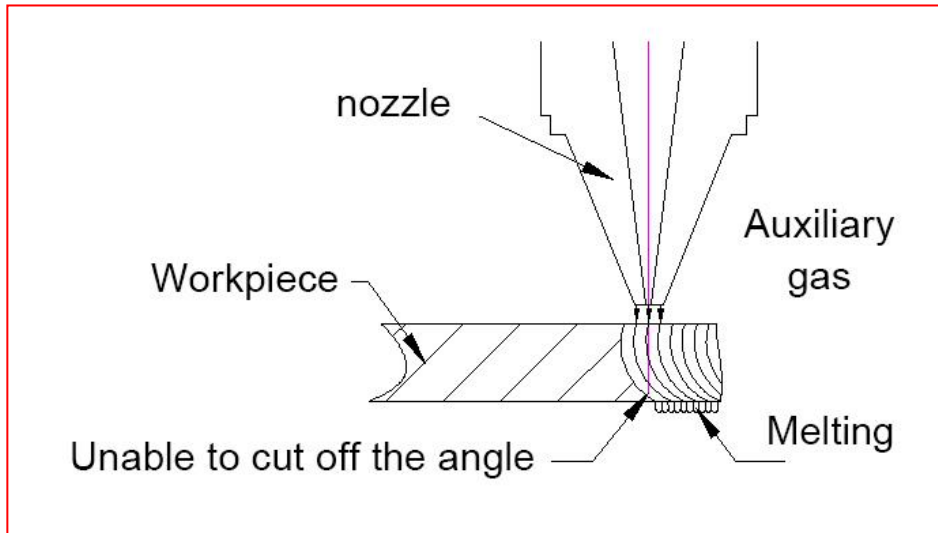

How to judge the cutting speed the speed by the cutting spark: generally, the cutting spark spread from the top to the bottom, if the spark tilts, the speed is too fast; If the spark spread a little or not spread, condensed together, then speed is too slow. As shown in the figure, the cutting speed is appropriate, as shown in figure 3-14 below. The cutting surface presents a relatively smooth line, and the lower part is free from melting.

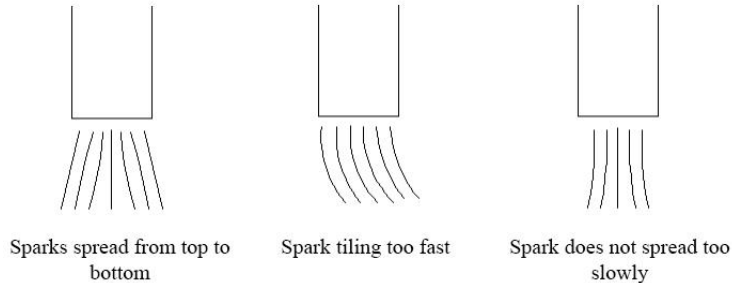

3 cutting height: the cutting height has little influence on the cutting quality of the workpiece. Set it too low, the slag removal ability of the auxiliary air pressure is strong, but it is easy to reverse slag to the protective lens and damage the protective lens. Too high, poor slag removal ability, need to increase air pressure, gas consumption increase. Generally, the cutting height should be set between 0.5 and 1.5. There is a small amount of bead-like slag below the cutting workpiece, and the cutting section grain is good.

4 Focus point: the position of the focus point has an important effect on laser cutting, how to choose the focus, and the effect of the focus on plate punching and cutting section. Nitrogen cutting stainless steel general negative focus; Oxygen - cut carbon steel plates are generally in positive focus.

Nitrogen cutting stainless steel general negative focus; Oxygen - cut carbon steel plates are generally in positive focus

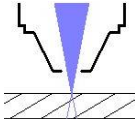
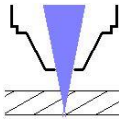
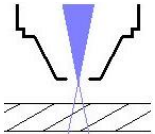
Name and location on focus	Cutting material and section features
Zero focal length: the laser focus is on the cutting surface of the workpiece	 <p>Suitable for thin carbon steel under 1. Mm, etc. The focus is on the workpiece surface, the upper surface is cut smooth, the lower surface is not smooth.</p>
Negative focal length: the laser focus is below the surface of the cutting part	 <p>Nitrogen cutting stainless steel cutting method; The focus is below the plate surface, so the smooth surface has a wide range, the cutting slot is wider than the zero focal length slot, the cutting gas flow is larger, and the punching time is longer than the zero focal length slot.</p>
Focal length: the laser focus is above the cutting surface	 <p>Oxygen used for cutting carbon steel; Blackened surface, rough surface.</p>

5 Nozzle: the nozzle commonly used aperture is Φ 1.0, 1.5, Φ Φ . 2.0 Φ . 2.5 two kinds. Aperture size difference is: cutting thin plate: use Φ 1.5 nozzle, cut surface will be fine. Use Φ 2 nozzle, cut surface coarser, corner place easy to melt. When cutting thick plate: because of high cutting power, relatively longer cooling time, relative cutting time also increases. Use Φ 1.5 nozzle, gas diffusion area is small, so is not so stable when using. With above Φ 2 nozzle, gas diffusion area is large, the gas flow velocity is slow, so the cutting is stable. Nozzle is divided into double layer nozzle and single layer nozzle : oxygen cutting carbon steel nozzle choice: generally uses double nozzle, generally use single layer nozzle within 3 mm thickness; 3-12 mm generally adopts double Φ 2.0; Nitrogen cutting stainless steel nozzle selection: generally use single-layer nozzle, use single-layer Φ 1.5 below 2mm thickness, use single-layer 2.0 above 2mm thickness. The size of the nozzle aperture has an absolute influence on the cutting quality and the perforation quality. The larger the nozzle

aperture is, the poorer the relative protection of the focusing lens will be. Because there is a large probability of the molten spark flying during cutting and the upward bounce, the shorter the life of the lens will be. At the same time, the quality of the nozzle is also an important factor affecting the cutting quality. The shape of the nozzle is shown in the figure below.

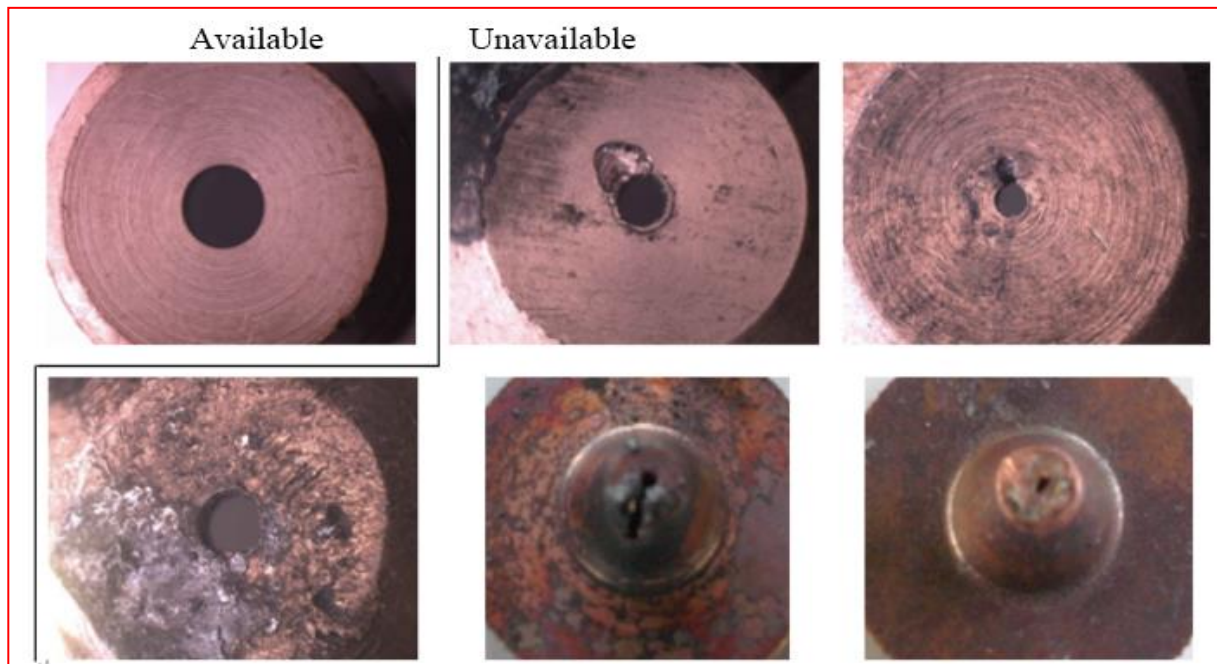

6 Air pressure: The main function of cutting gas is cooling and protection. Oxygen can help to burn and dissipate heat, blow off the melt generated by cutting, prevent the cutting melt from rebounding into the nozzle, protect the focusing lens and protect the mirror. The effect of cutting gas and pressure on the quality of the cut: the cutting gas helps to cool the heat and combustion, blow off the melt, and obtain a better quality cut section. When the pressure of the cutting gas is insufficient, the following effects are caused: the melting occurs during cutting; the cutting speed cannot be increased, and the production efficiency is affected. When the pressure of the cutting gas is too high, the influence on the cutting quality: when the pressure is high, the airflow is too large, the cutting surface is rough, and the slit is wide; when the airflow is too large, the cut section is partially melted and cannot be formed well.

The influence of the pressure of the cutting gas on the perforation. When the gas pressure is too low, the laser does not easily penetrate the cutting plate, and the drilling time increases, resulting in low productivity. When the gas pressure is too high, the penetration point is melted, and a blast hole is formed to form a large melting point, thereby affecting the quality of the cutting. When laser drilling, generally, a

higher gas pressure is applied to the punching of the thin plate member, and a lower gas pressure is applied to the punching of the thick plate member. Oxygen cuts ordinary carbon steel. The thicker the material, the lower the pressure of the cutting gas. Nitrogen cut stainless steel, the thicker the material, the higher the gas pressure, the cutting gas pressure is always above the high pressure state of 1.2mpa.

7 Lead-in line: A line connecting the punching position to the contour of the workpiece. The lead-in line is also called the lead-in line. The benefit of adding a lead-in: when the hole is blasted, the resulting workpiece scrap is reduced. The quality of the first cut surface can be improved. It can improve the appearance of the knife edge. It is easier to start the knife when cutting stainless steel. Stainless steel, carbon steel lead set requirements 2mm stainless steel can use straight lead; 2mm or more generally adopts straight line 3-5mm plus R0.2-R0.8 around small arc; carbon steel generally adopts straight line 3-5mm plus R0.5— The arc of R3 is introduced, and the thicker the plate, the larger the R value. Oxygen cutting thick steel carbon steel 5mm or more, cut small holes, it is recommended not to add.

8 perforation direct cutting: generally applicable to carbon steel plate below 1.2mm, stainless steel perforation, small perforation aperture. Segmented perforation: generally applicable to carbon steel plates of 3mm or less and stainless steel perforations of 1.5mm or more. Progressive perforation: generally applicable to carbon steel plate of 3mm or more, perforation of 2mm-3mm stainless steel, fast perforation speed, large perforation aperture ($\Phi 2$ - $\Phi 3$ mm), perforation height > 3 mm, pressure < 2 bar. According to the actual situation. Three-stage perforation: generally applicable to carbon steel thick plate more than 6mm, stainless steel more than 5mm. Thick carbon steel sheets have a long time for ordinary perforation and are easy to explode. The purity of oxygen is at least 99.5%. The lens, protective mirror and nozzle have good materials. The laser mode is free of distortion and wastes time, and the collision alarm is prone to occur. After the progressive perforation is used, the piercing time is greatly shortened, and the blasting rate is lowered.

problem	possible reason	Solution

<p>Punch at the beginning of the punch</p> 	<p>The duty cycle is too high</p> <p>Punching power is too large</p> <p>Too much pressure</p> <p>The focus is wrong</p> <p>Punching is wrong</p>	<p>Reduce power by 10% each time</p> <p>Reduce the duty cycle, 1% - 2% each time</p> <p>Reduce the air pressure, change the focus every 0.1bar, check the punching mode every 0.1-0.2mm, whether it is continuous wave drilling, etc.</p>
------------------------------------------------------------------------------------------------------------------------------	--------------------------------------------------------------------------------------------------------------------------------------------------	-------------------------------------------------------------------------------------------------------------------------------------------------------------------------------------------------------------------------------------------

<p>Hole in the process of hole</p> 	<p>The duty cycle is too low</p> <p>Low power</p> <p>The focus is wrong</p> <p>Low air pressure</p>	<p>reduce speed</p> <p>Check the amount of defocus</p> <p>Increase power, 5%-10% each time</p> <p>Increase air pressure, 0.1-0.2bar each time</p>
------------------------------------------------------------------------------------------------------------------------	-----------------------------------------------------------------------------------------------------	---------------------------------------------------------------------------------------------------------------------------------------------------

<p>End of punching, blasting before cutting starts</p> 	<p>Insufficient punching time</p> <p>Low punching power</p>	<p>Increase the punch time, 0.5sec each time</p> <p>Increase the punching power, 5% each time</p> <p>Increase duty cycle, 1% - 2% each time</p> <p>Use slow speed</p>
------------------------------------------------------------------------------------------------------------------------------------------	-------------------------------------------------------------	-----------------------------------------------------------------------------------------------------------------------------------------------------------------------

9: In the process of production and processing, before the mass production, there must be a process of trial cutting, called “testing knife”. Through the test knife, the process parameters required for sheet cutting can be adjusted, but the test knife and The whole board cutting process will be slightly different and needs attention. Test knife: first select a circle to cut, the main purpose is: check whether the parameters can be cut normally, whether the cutting section is qualified, know the deviation between the actual size and the size after cutting, so as to compensate the size in mass production, and try to Select the most complex contour in the machining pattern to test the knife.



Precautions for mass production after test knives:

1 Pay attention to the limit of the machine tool. The plate should not be too close

to the edge, pay attention to the starting position of the cutting head.

2. Pay attention to whether the direction of the graphic is consistent with the direction of the plate when cutting, and the dimensional deviation when testing the tool should be compensated to the figure of mass production.

3. It is best to simulate the program once before cutting to ensure the correctness of the program.

4. The speed in mass production is 80% of the speed at which the knife is tested.

5. The first part to be cut during mass production must be measured to ensure that it is safe to be inspected and, if necessary, sampled during the cutting process.

6. See if the parts are turned over during mass production, it is easy to hit the cutting head, and an alarm is generated. It is necessary to suspend the cutting. Otherwise, collision will occur easily, and the plate will be moved. The solution is to set the micro-connection to the cutting workpiece. The laser head needs to be recalibrated.

7. Before cutting, manually check whether the blowing is normal. During the cutting process, pay more attention to the use of gas to prevent the lack of gas in the middle, resulting in scrapped parts.

8. During the cutting process, the operator is not allowed to leave the console to avoid an emergency.

9. The starting point is set at the lower right of the part to reduce the error caused by the deformation during the cutting process.

10. The part is at least 10mm from the edge of the board.

11. With film cutting: with the film side up, if there are films on both sides, the lower surface film must be torn off, otherwise the slag will be slag; according to the film film condition, if the film is firmly attached, it can be cut normally; if the film is not attached In case of hard work, it is necessary to use a snoring to remove the film and then cut it (recommended: high-viscosity, viscosity 120, black and white film with a thickness of 0.05 mm or less);

12. De-filming: The cutting path is marked first and then cut. Simply put, the same path is repeatedly cut twice, once with a small power marking, the film is cut off, and the metal is cut again with high power. The height of the film can be adjusted by adjusting the degree of cut in the film removal parameter, and the wider the height, the smaller the probability that the film is blown up.

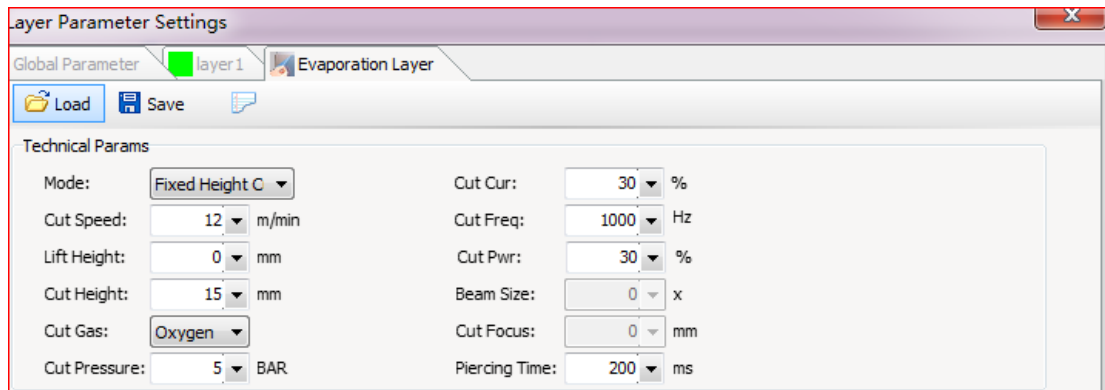
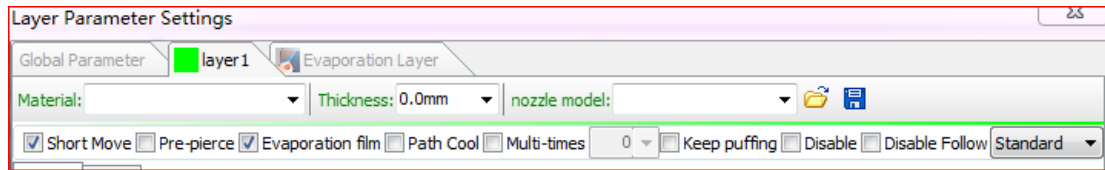

13. Overview of different material methods

- Carbon steel cutting process: This material will get better results when cut with oxygen. When oxygen is used as the processing gas, the cutting edge is slightly oxidized. For plates up to 1 mm thick, high pressure cutting can be performed using nitrogen as a process gas. In this case, the cutting edge will not be oxidized. A plate having a thickness of 10 mm or more, and oiling the surface of the workpiece during processing can obtain a good effect.
- Tainless steel cutting process: oxygen can be used in the case of acceptable cutting end oxidation; high pressure nitrogen is used to obtain the edge without oxidation and burr, no need to deal with it. Coating the oil film on the surface of the board can get better perforation without sacrificing processing quality. As shown in the figure, a stainless steel piece cut with high-pressure nitrogen has small burrs under the workpiece to increase the nitrogen pressure.
- Aluminum cutting process: despite the high reflectivity and thermal conductivity, aluminum with a thickness of 6mm or less can be cut, depending on the alloy type and laser capability. When cut with oxygen, the cutting surface is rough and hard. When nitrogen is used, the cutting surface is smooth. Pure aluminum is very difficult to cut because of its high purity.
- Brass and copper cutting process: both materials have high reflectivity and very good thermal conductivity. Brass can be cut with nitrogen; copper can be cut and the process gas must be oxygen.
 - Special process with film cutting

a with the film facing up, if there are film on both sides, the lower surface film must be torn off, or hang slag; according to the plate film, if the film is firmly attached, it can be cut normally; if the film is not firmly attached, it must be used Cutting after removing the film (recommended: high viscosity, black and white film with a viscosity of 120 and a thickness of 0.05 mm or less);

b De-filming: The cutting path is first marked and then cut. Simply speaking, the same path is repeatedly cut twice, once with a small power marking, the film is cut off, and the metal is cut at a high power again. The width of the film can be adjusted by adjusting the degree of cut in the film removal parameter, and the wider the width, the smaller the probability that the film is blown up.

- Special process layered cutting;

The contours of each workpiece are not the same, some are easy to cut, but some are more difficult to cut, such as small holes, sharp corners and so on. In order to ensure the cutting quality and cutting efficiency of the whole workpiece, we adopted the layered cutting method, so that we can adopt different process parameters to control the cutting of different contours, which can not only ensure the cutting quality of the difficult contour but also improve the cutting efficiency of the easy contour. Generally speaking, layered cutting is mainly divided into continuous wave cutting layer and pulse cutting layer.

Pulse cutting features: low heat input, small deformation of the workpiece, slow cutting speed, high pressure, and rougher cutting section than continuous wave cutting.

Applications: Sharp corners, small contours, irregular lines (especially the lines broken up by the spline) and precision parts requiring less thermal deformation.

Generally speaking, carbon steel does not use pulse cutting more than 4MM, stainless steel does not exceed 3MM, aluminum alloy generally does not use pulse cutting.

Chapter 4 Maintenance

Review

In order to ensure the normal use of the laser cutting machine, the equipment must be routinely maintained and maintained. Because the whole machine tool is

made up of high-precision parts, it must be taken care of in the daily maintenance process, strictly in accordance with the operating procedures of each part, and maintained by a special person, and must not be barbaric to avoid damage to components.

General guidelines

Professional lubrication with the most suitable lubricant is the premise of maintaining the quality of machine tools. This avoids running failures and their consequences. In this sense, the following considerations should be noted

Before putting into operation: Before the machine is put into operation, the machine must be carefully lubricated according to the lubrication instructions. If the machine has not been used for a long time (eg ocean transport), the lubrication of the entire machine must be checked.

Lubrication precautions: machine tool lubrication according to the lubrication diagram and the description of the lubrication diagram. I suggest you also pay attention to the following points:

Do not open the refueling and discharge ports for more than the specified time and keep them clean.

Use only non-fibrous wipes for scrubbing oil grooves and lubrication points, do not use waste wool, do not use kerosene and gasoline, and use a lean liquid spindle oil ("spray lubricant").

Synthetic lubricants are not allowed to be mixed with mineral oils or synthetic oils from other manufacturers. This is true even for synthetic oils of the same characteristics produced by other manufacturers.

Waste oil can only be discharged when the machine is warm.

Special attention must be paid to the innocent treatment of used oil.

Cleaning Precautions: The entire equipment must be thoroughly cleaned at specified intervals. Obvious dirt can be scrubbed or removed with an industrial vacuum cleaner.

Safety Tip: When performing maintenance work, the machine must be turned off by the main switch to turn it off.

Safety regulations must be strictly observed to avoid accidents.

The maintenance items that the user should keep are as follows:

Acetone: a purity of 99.5%, water less than 0.3%, a bottle of 500ml capacity.

Absorbent cotton: 5 packs.

Alcohol: 500ml, purity 99.5% or more.

Lens paper: 5 copies.

Blowing ball: one.

Dropper needle: one (medical).

Plexiglass: 200 × 300 × 20.

Inkslab;(red): one piece.

Cotton swabs: two packs.

Multimeter: one.

4.1 Daily maintenance and maintenance of peripheral equipment

For routine maintenance of peripheral equipment such as chillers, voltage regulators, and lasers source, please take the corresponding instruction manual as reference. The following is only brief description.

The main function of the high-power chiller is to cool the laser source so that the laser is in a constant temperature working condition, thus good and regular maintenance is the key to ensure the normal operation of the machine;

And the circulating water of the chiller requires the use of distilled water. However, due to the water quality problem, certain impurities such as minerals and dust still exist in the circulating water, and the dust in the environment may also enter the circulating water in some operation steps, and the deposition of these impurities may cause Blockage of water system and cutting machine components (such as metal filters, heat exchanger heads in the cutting machine), which seriously affect the cutting effect and even burn out the optical components. Dust and other debris in the environment accumulate on the radiator and water pump of the chiller, resulting in poor heat dissipation of the radiator and the pump, resulting in poor cooling, burning of the compressor, and burning of the pump. This will directly affect the cutting effect; therefore, cold water The daily maintenance of the machine is particularly important; the daily maintenance of all types of chillers must be carried out in strict accordance with the respective chiller maintenance instructions (see attached table).

Machine Name: Tongfei chiller Machine Model: Machine No.:		
Maintenance period	Maintenance content	Maintenance target
daily	1. Check if the chiller temperature setting is normal (set temperature 20±1°C)	Ensure that the cooling water supplied to the laser is at a normal temperature
	2. Check whether the chiller waterway seal, water temperature and water pressure meet the	Ensure that the equipment is operating properly to

	requirements.	prevent water leakage
	3. The working environment of the chiller is kept dry, clean and ventilated	Conducive to the good operation of the chiller
monthly	1. Use neutral detergent or high-quality soap to remove dirt from the surface of the chiller. Do not use benzene, acid, milling, steel brush, hot water, etc.	Ensure the surface of the chiller is clean
	2. Check if the condenser is blocked by dirt. Please use compressed air or a brush to remove the dust from the condenser.	Ensure the normal operation of the condenser
	3. Cleaning the air filter: a. Open the panel of the air filter of the machine assembly, pull up the air filter and pull it out; b. The dust on the filter net can be removed by using a vacuum cleaner, an air spray gun and a brush. After the cleaning is completed, if the filter is wet, shake it and dry it before putting it back. c. Cleaning time: once every two weeks, if the dirt is serious, please wash it regularly.	Prevents poor cooling, pumps and compressors burns out which caused by poor heat dissipation

Table 5-1 chiller maintenance instructions

	3. Cleaning the air filter: a. Open the panel of the air filter of the machine assembly, pull up the air filter and pull it out; b. The dust on the filter net can be removed by using a vacuum cleaner, an air spray gun and a brush. After the cleaning is completed, if the filter is wet, shake it and dry it before putting it back. c. Cleaning time: once every two weeks, if the dirt is serious, please wash it regularly.	Prevents poor cooling, pumps and compressors burns out which caused by poor heat dissipation
	4. Check the water quality of the tank and follow up	Good water quality ensures the laser running properly
	5, check if the chiller pipeline any leakage or not	Ensure that the chiller has no water leakage
Every three months	1. Check electrical components (such as switches, terminals, etc.) and wipe then clean with a dry cloth.	Ensure that the surface of the electrical part of the chiller is clean and prolongs its service life.

	<p>2, replace the circulating water (distilled water), and clean the water tank and metal filter; if equipped with ROFIN laser, the cooling water can be replaced with cooling water after adding anti-corrosion inhibitor for half a year. If equipped with PRC laser, propylene glycol is added to the cooling water. The cooling water can be replaced once every six months.</p>	<p>Make sure the laser running properly</p>
<p>°</p> <p>★★★ Note:</p> <p>Requirements for long-term suspension:</p> <ol style="list-style-type: none"> Place the chiller and water pipe away from dust. Pull the power cord away from the socket and wipe the power cord clean; Cleaning the unit body: When cleaning the inside of the unit, do not let water splash on the electronic parts; Completely remove water. 		

4.2 The maintenance of laser source and laser cutting head

- Laser source is the core equipment in laser cutting machine. It provides cutting light source for laser cutting machine. To ensure your laser cutting machine to work normally with high quality, while ensuring reliable operation of your laser source and extending the service life of laser source, remind you Check and maintain your laser regularly.

Fiber lasers can basically be maintenance-free. Mainly need to take care of the observation of cooling water and cooling air conditioning is normal; whether the voltage is normal! If there is an abnormal alarm, contact FULL SPECTRUM after-sales engineers immediately!

- Laser cutting head maintenance

Protection lens maintenance (see illustration)

The protection lens is located in the lower part of the centering mold and is susceptible to dust pollution. It is recommended to clean it every week.

Removal of the protection lens box

Hold the drawer of the protection mirror box with your thumb and index finger, slowly pull out the protection mirror box, and then seal the drawer with adhesive tape to prevent dust from contaminating the focusing lens.

Protection mirror box installation

The protective lens is a flat mirror that can be placed directly into the mirror box. The procedure in which the lenses are mounted is reversed as when the lenses are removed. Press the lock button on the drawer with your finger and insert it into the

drawer. When the lock button pops up, the assembly is completed.

- Lens cleaning

A. Prepare tools: dust gloves / finger cots, long fiber cotton wool, isopropyl alcohol, rubber gas blowing. B, cleaning method: 1, the left thumb and index finger with a finger cot. 2. Spray isopropyl alcohol onto the cotton wool stick. 3. Gently pinch the side edge of the protective lens with your left thumb and forefinger. Note that the fingertips should not touch the surface of the lens to avoid leaving marks. 4, the lens facing the eyes, the right hand with a cotton wool stick, from bottom to top or from left to right, gently wipe the lens in a single direction, (do not wipe back and forth to avoid secondary pollution of the lens), and blow with rubber gas The surface of the lens. Both sides must be cleaned. After cleaning, re-confirm that there are no residues: detergent, cotton wool, foreign matter, and impurities.

The cleaned lens should not be exposed to the air, installed as soon as possible or temporarily stored in a clean, sealed container.

- Replacement of the bottom kit

1. Unscrew the mechanical part of the sensor and remove it.
2. Replace the new bottom kit and tighten.
3. Adjust the bottom kit to the right position.

18.10 nozzle replacement

Unscrew the nozzle by hand, as shown in Figure 9. Replace with a new nozzle and retighten it with the appropriate force.

Calibrate the floating capacitor again after replacement.

- Replacement of ceramic body

1. Remove the short cable, remove the mechanical part of the cutting head, and remove the nozzle.
2. Then unscrew the fastening nut of the ceramic body and take out the ceramic body, as shown in the figure 9.
3. Install the new ceramic body, it need aligned that two positioning posts on the mechanical part of laser head.
4. Firmly lock the compression nut and reassemble it on the connector.

- Optical system checking and cleaning

Precautions

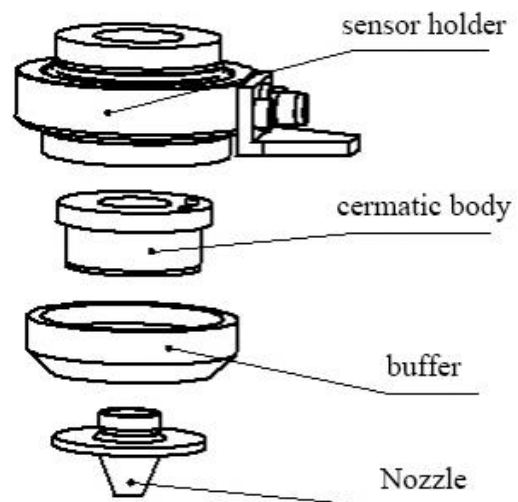

To ensure the lens used normally, the optical lens (protect mirror, focus lens, collimating mirror, etc.) should be checked in time. Do not touch the surface of the lens directly with hand during the check, otherwise the mirror surface will be easily scratched. If there is oil or dust on the mirror, please clean it.

1) Optical lenses are strictly prohibited from being cleaned with water, detergent, etc. The surface of the lens is coated with a special film, It will damage the surface of the lens if cleaned with water, detergent etc.

2) Do not place the lens in a dark, damp place, as this will age the surface of the lens.

3) The surface of the lens is stained with dust, dirt, or water vapor, which easily absorbs the laser to damage the lens coating; it will affects the quality of the laser beam, if damaged lightly, There will be no laser beam, if damaged seriously.

4) When the lens has little damage, it should be sent to the supplier to repair in time. Try not to use the damaged lens, otherwise it will accelerate the damage to the lens which can be repaired before.

5) When installing or replacing the mirror or focusing lens, do not use too much pressure, otherwise it will cause deformation of the lens and affect the quality of the beam.

a.Method of installing or replacing an optical lens

1)Before installing the optical lens, wear cleanly, clean the hands with soap or detergent, and wear white clean and thin gloves; do not touch the lens with any part of the hand; when taking the lens, wear gloves and Take the side of the lens and do not touch the lens coating surface directly.

2)When assembling the lens, do not blow the lens by mouth; the lens should be placed on the clean table steadily, and a few lens papers should be placed under neath. Care should be taken when taking the lens to prevent bumps and falls, and no force should be applied to the coated surface of the lens; the lens holder for the lens should be cleaned, and the dust and dirt in the lens holder should be cleaned with a clean air spray gun. Then, remove the lens and gently put it into the lens holder.

3)When mounting the lens to the lens holder, do not use too much force to fix the lens to avoid deformation of the lens, thus affecting the quality of the beam.

4)Precautions when replacing the optical lens: Be careful when removing the lens from the box to prevent the lens from being damaged; do not apply any pressure to the lens before the wrapping paper is opened; When take the mirror and focus lens from the box, wear clean gloves and take it from the side of the lens; when removing the wrapping paper on the lens, avoid dust and other objects falling on

the lens; after removing the lens, use a spray gun to remove dust from the mirror, and then put the lens on the special paper for the optical lens; Clean the dust and dirt on the lens support frame and the fixing frame, and no other objects are dropped on the lens during assembly; when the lens is mounted on the lens holder, do not use excessive force to avoid deformation of the lens; After assembly, clean the dust and foreign matter on the lens with a clean air spray gun.

b. Procedure of clean the lens

Different lenses have different cleaning methods. When the mirror is flat and has no lens holder, use lens paper clean it, for example Cleaning the reflection mirror; When the mirror is curved or with a mirror holder, use a cotton swab to clean, such as cleaning the focus lens.

1) Steps to clean the lens with lens paper: Use a clean air spray gun to blow off the dust on the lens surface; use alcohol or lens paper to clean the surface of the lens. Never use a dry lens paper to pull directly on the mirror surface. Instead, flatten the lens paper to the surface of the lens, drop 2 to 3 drops of high-purity alcohol or high-purity acetone, and slowly pull out the lens paper horizontally to the direction of the operator. Repeat the above operation several times until the mirror surface is clean; if the mirror surface is very dirty, fold the lens paper 2 or 3 times, repeat the above steps until the mirror is clean.

2) Steps to clean the lens with a cotton swab: first blow off the dust on the mirror with a spray gun; then use a clean cotton swab to remove the dirt; Move a new cotton swab dipped with high-purity alcohol or acetone from the center of the lens to the edge of lens making a circular motion. Scrub the lens, after each circle of cleaning, change another clean cotton swab and repeat the above operation until the lens is clean. Never use the used cotton swab to operate it; clean the lens with a clean cloth and remove the residue on the mirror. Be careful not to scratch the mirror surface; take the cleaned lens to a place with sufficient light. If the reflection of the lens is good, it indicates that the lens is clean. If the reflection of the lens is not good, continue to clean the lens; Put the cleaned lens on the lens holder in accordance with the method described above.

c. Storage of optical lenses

- 1) The optical lens is stored properly to keep the lens quality in a good condition.
- 2) The storage environment temperature is 10~30°C. Do not put the lens into the freezer or similar environment. Otherwise, it will condense and frost when it is taken out, which will easily damage the lens. The temperature of the storage environment is not more than 30°C, otherwise it will affect the coating on the lens surface.
- 3) Keep the lens in the box, the lens should be placed in a non-vibrating environment,

otherwise it will easily cause deformation of the lens, thus affecting the performance of the lens.

- Maintenance during long-term storage: When the machine is not used for a long time, please apply grease on the moving parts of the machine and wrap the anti-embroidered paper. Check other parts regularly to see whether there is any rust and De-rusting and rust-proofing treatment of rusted parts.(if the condition can be added with a dust cover), and regularly clean and check the machine.

- Linear slide and rack and gear maintenance: because the different lubricant types used in the two rails, the equipment also adopts two different lubrication methods. The guide rail adopts the electric automatic refueling pump to refuel automatically . When the automatic oil pump is too low, the system will alarm automatically, you need to join the Great Wall heavy-duty vehicle gear 90GL-5 lubricating oil at the oil filling port, and reset after the oil filling is completed. The rack needs to add oil to the machine body every 7 days. The oil used is Mobil 00# lithium grease. If the linear slide is not properly lubricated, the friction of the rolling portion will increase, and long-term use will become the main reason for shortening the life. The linear slide and sprocket chain grease is a lithium-based grease. It is recommended to use the Tsutsui lithium grease MP-3;

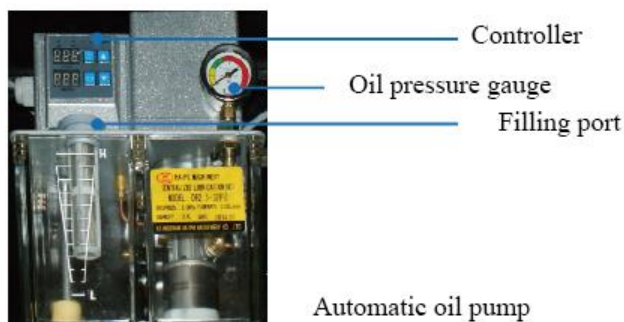

- Machine cleaning and maintenance

Mainly maintenance is the transmission part of the machine body and the cleaning of work surface. 1. It is necessary to clean the work surface and the dust and debris on the work table every day. 2. The dust and debris on the track dust cover must be cleaned every day to prevent the dust cover from being scratched and shorten its service life.

- Water tank cleaning and maintenance

The main function of the water tank is to protect the laser and the cutting head by controlling the water temperature to ensure the normal operation of the laser equipment. It is an important accessory and must be cleaned and maintained.

1. It is necessary to clean the filter every day to ensure that the ventilation and

heat dissipation are good, so as to ensure the water temperature is normal. "As shown below"

2. The temperature of the water tank is generally maintained at 22°C to 28°C (in summer the high temperature can be set to 28-35°C, the low temperature can be set to 26-29°C, pay attention to the temperature difference between the equipment temperature and the external environment temperature can not be greater than 5°C, please adjust in summer Otherwise it will have a serious impact on the device). "As shown below"



3. Change the water every week (note: be sure to use distilled water, recommend Watson's distilled water), wash the water tank before changing the distilled water every time, recycle the dirty water in the equipment once with new distilled water, and then inject distilled water again.

- Cleaning and maintenance of the electric cabinet:

1. The filter of the electrical cabinet is cleaned weekly and can be cleaned with compressed air or water. If the filter is dirty, replace it.



2. The electric cabinet will be cleaned once every three months. If the environment is bad, the dust will be cleaned once a month. When the dust is cleaned, all the power supplies must be powered off, and then the doors on both sides of the power supply cabinet are opened. Do not touch the electronic components inside the cabinet directly. Clean the dust in the cabinet with a vacuum cleaner (do not use

compressed air)

3. Clean the computer host every six months. (If environment is bad every 3 months need clean once) You need to clean the computer host, remove the fixing strip, and remove the cover. The motion control card and memory module can be removed and cleaned. Please use a clean and dry cloth to do this.

Chapter 5 Common fault analysis

5.1 software enters the demo interface failure

Check if the device manager finds the Cypcut electronic motion control card and checks if the control card driver is installed.

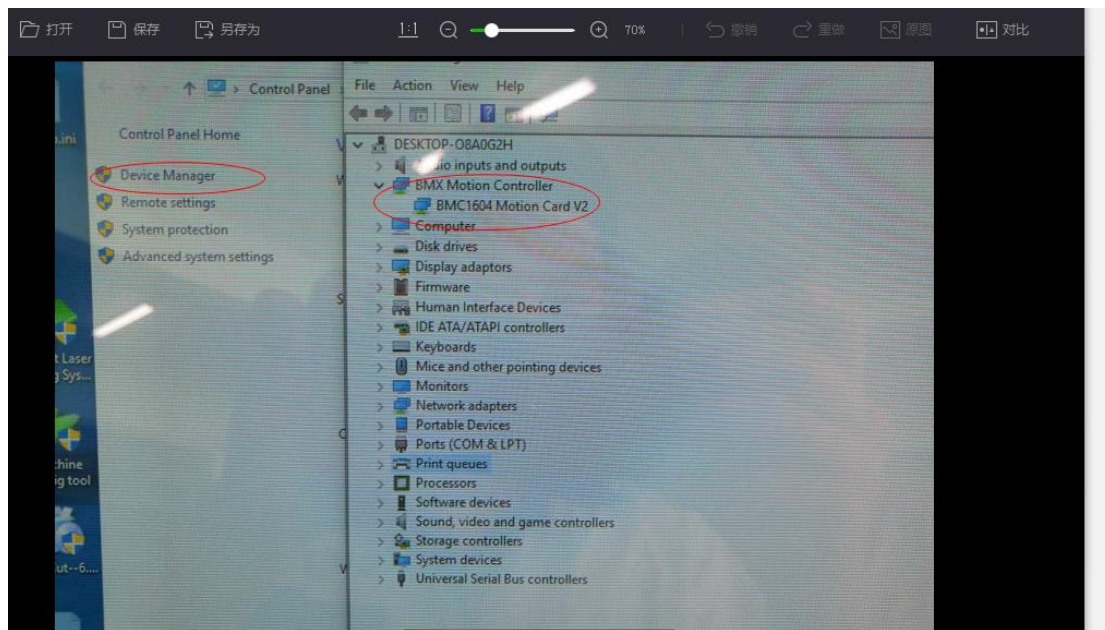

If the motion control card is not found in the device manager, please check the 2 small lights (LED7, LED8) on the top of the control card to flash. If it does not flash alternately, the control card may be faulty and can be upgraded or sent back for repair.

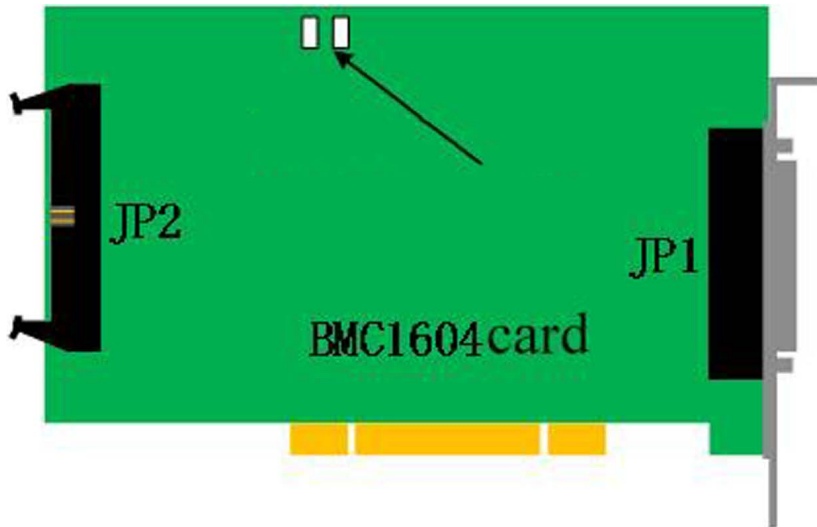

Check the interface to see if the system has expired.

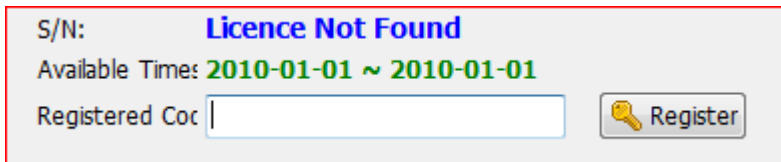

160X series control card, CypCut software requires 6.3.702.x version and above version to support 60X series control card, check whether the serial number has multiple repeated codes such as ZZZZZ, re-plug the control card to see if the serial number changes, and then re-encrypt and decrypt after the change.

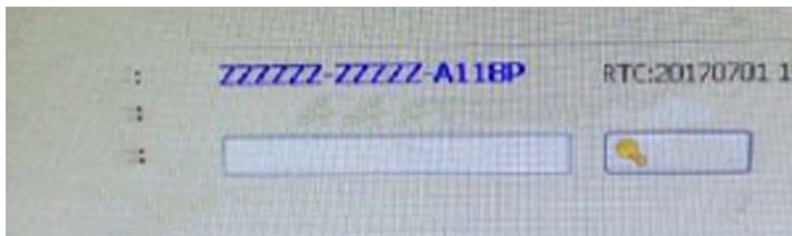

External dongle, check if the RTC time behind the serial number is the current time. If the time is wrong, the dongle may be damaged.

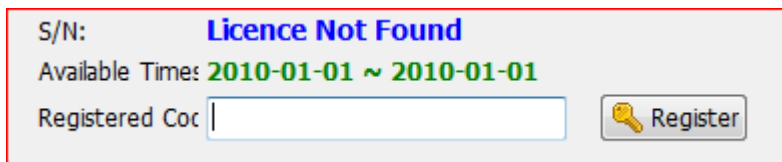

5.2 The laser source doesn't have light

If the laser shutter not open?

Check if the output signal of the PWM (up to 4.1V or 22V when the duty ratio is set to 100%) and DA (0~10V) is normal on the terminal board.

Relying on the communication-controlled laser, you need to check the configuration

of the network / COM port, whether it is connected

Check whether the external control module of the laser is faulty. The internal control can emit light. It does not mean that the external control module is normal.

The laser monitoring software is used to detect whether the laser receives control commands, such as DA and PWM signals.

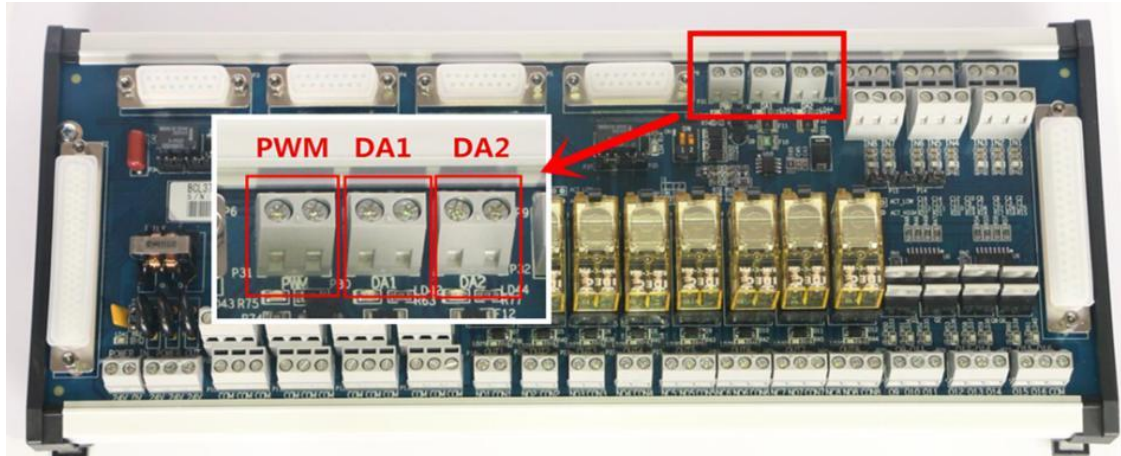

5.3 The light of Scanning and cutting out is not normal, Light leakage

Send a pulse in the diagnosis window to check whether the encoder feedback is normal. If the direction is wrong, reverse the direction of the encoder in the platform configuration tool. If the number is incorrect, modify the servo feedback pulse and other related parameters.

Check the accuracy of the error measurement is not high enough, the servo stiffness setting is too low

Sort the graph when generating the scan line, it is recommended to use the "local shortest move" strategy

If the light leakage is from IPG laser, the PWM signal is set to 5V, and other lasers check whether the servo interferes with the board.

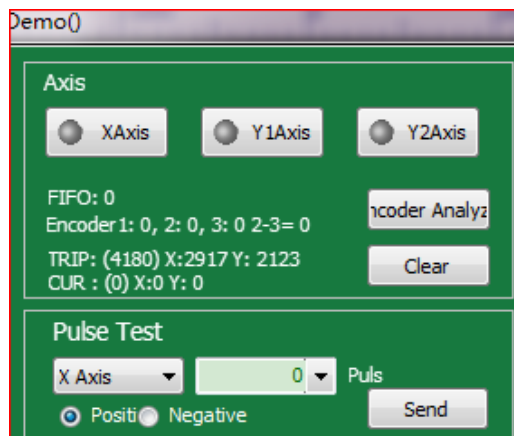

Check encoder pulse

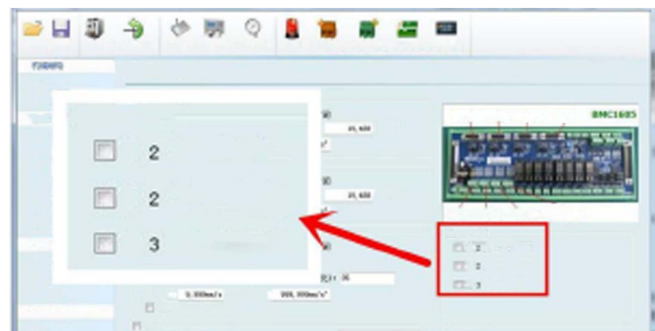

Encoder reverse

5.4 The cutting process is not the right size

Check if the size drawn on the original drawing is correct. The deviation of the size is about 10 filaments. You can add the appropriate slit compensation. If the scale becomes larger or smaller, adjust the pulse equivalent in the servo and platform configuration tool.

Mechanism

X Axis

ServoAlarm NO NC

Range Move need pulse

Max Speed Max Acc

Y Axis

Dual Drive ServoAlarm NO NC

Range Move need pulse

Max Speed Max Acc

5.5 Cutting deviation

Check if the servo motor is correctly equipped with a regenerative resistor

Check whether the trajectory of the cut part is deformed. If the distance of the empty movement changes and the closed pattern of the cutting is normal, check whether there is looseness between the servo and the reducer.

In the above case, the null acceleration and low-pass filtering frequency are set to be low or the same as the cutting portion, which can be temporarily solved.

5.6 Cannot perform breakpoint positioning after power failure or restart

If you check the option "only process selected graph", the processing breakpoint memory function will not be available

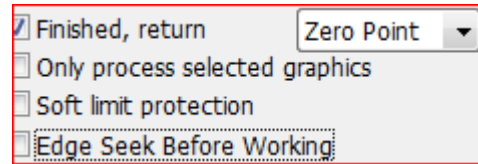
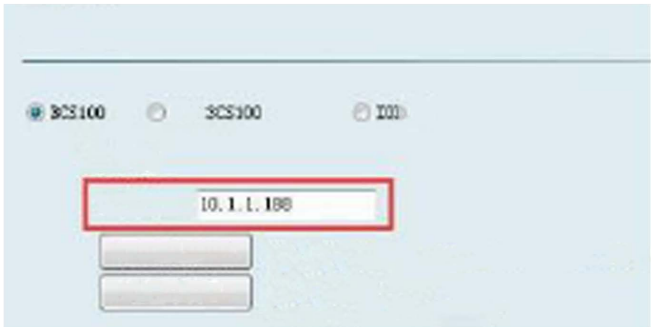

- In the process of using, the power should be returned to the origin at least once
- The state of power failure must be machining (this function is invalid if the frame is moved or moved).
- The file autosave.lxd is not damaged
- The basic information of the machine tool has not been changed (such as pulse equivalent, origin direction, etc.)
- The processing time must be more than 30 seconds

5.7 Height adjuster network timeout

Check that the IP address of the tuner in the platform configuration tool is the same as that in the network parameters of the tuner itself

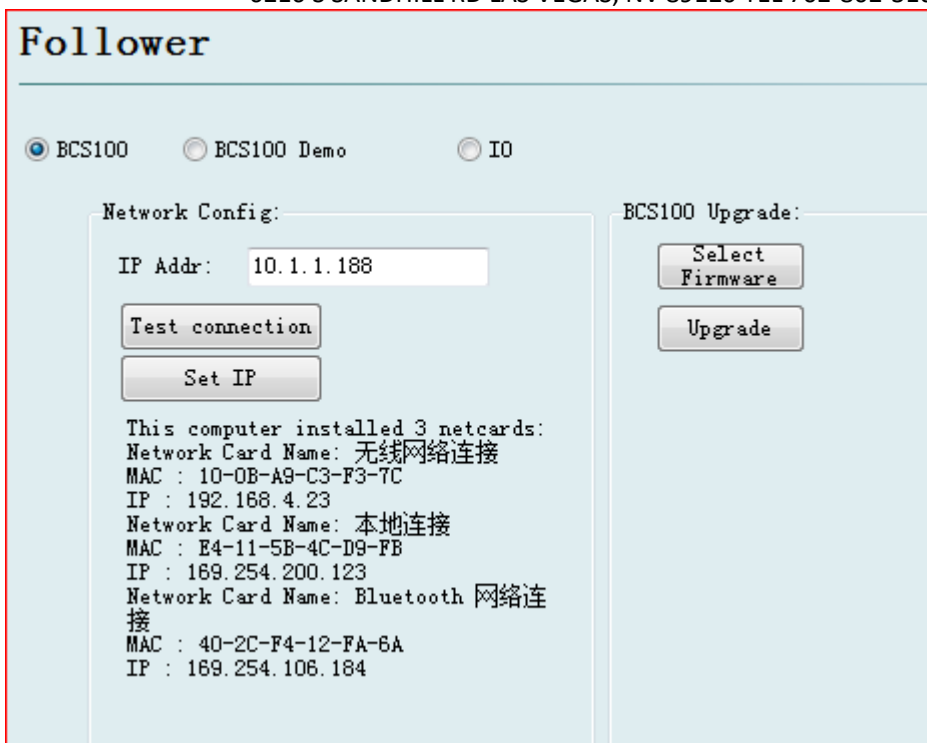

Check whether the IPv4 address of the computer network card is consistent with the first three segments and the adjuster, and the last segment is inconsistent

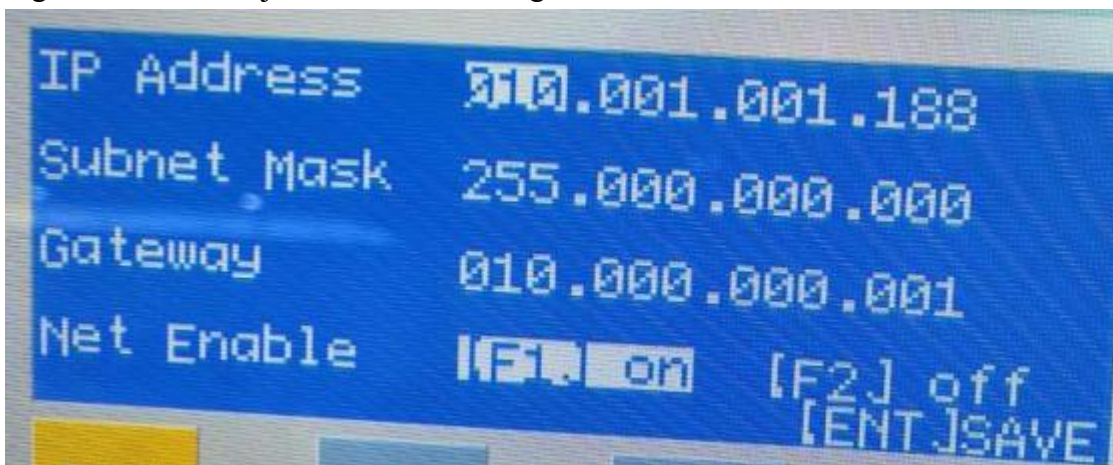

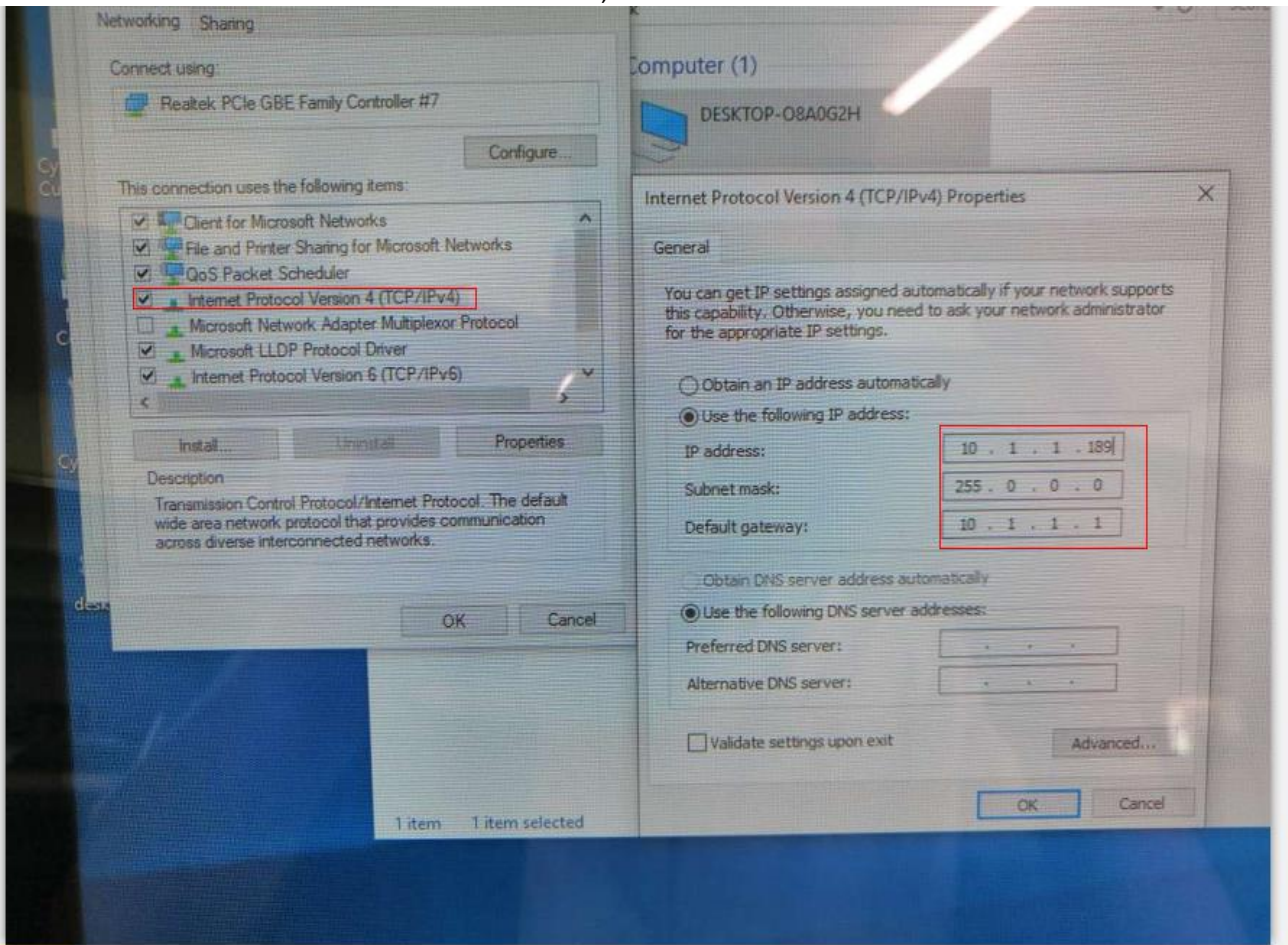

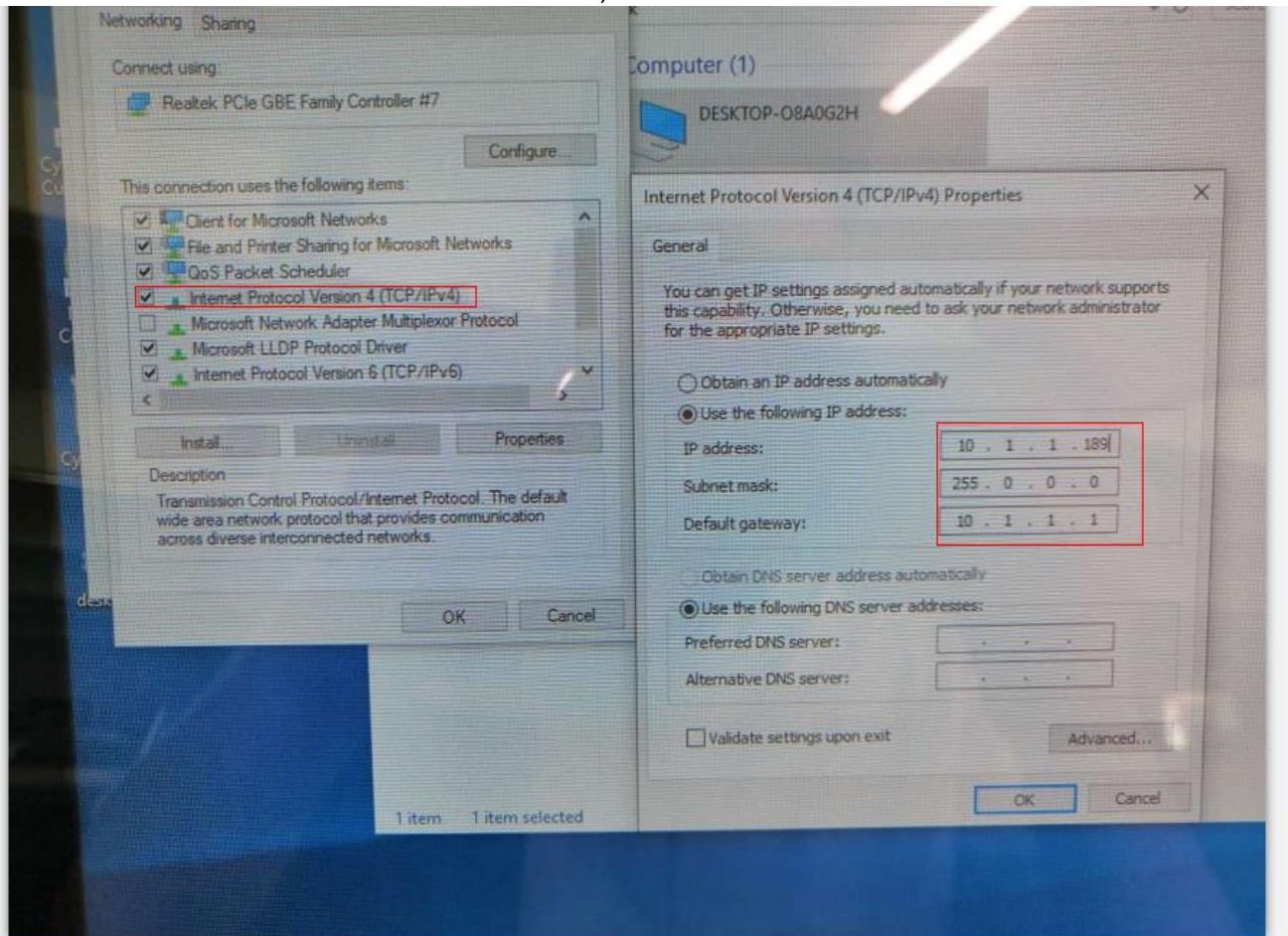

If the problem is not solved, please replace the network card

5.8 Homing is not normal

Check whether the Z trust number is enabled in the parameter of the platform configuration tool back to the origin, and the 15-core servo wire is not welded or falsely welded with the relevant encoder signal wire

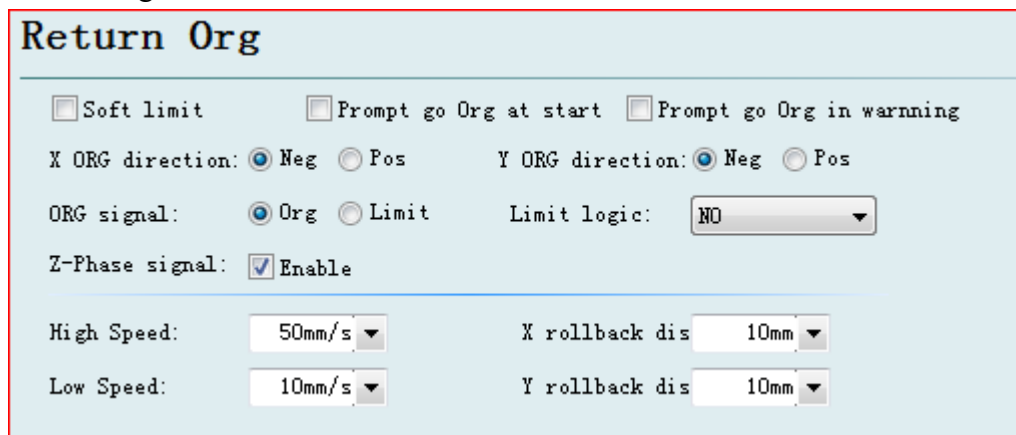

Check the origin or limit signal is always valid

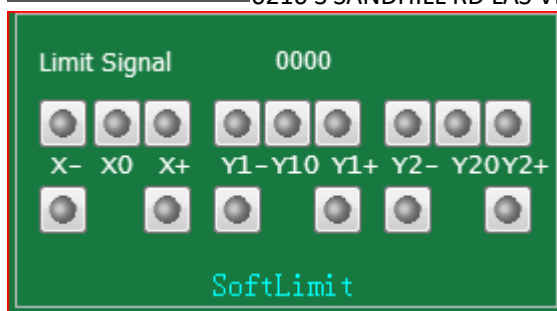

5.9 Axis movement is not normal

Check whether the 15-core wire and the 62-core wire are connected normally. No need to replace the board card. Exclude whether the board card damages the servo and whether the parameters are set incorrectly. 10 this alarm is sent by the software to the height regulator, but the height regulator does not execute the instructions sent by the software within a certain period of time, or does not respond after receiving the corresponding instructions from the height regulator. Check if there is any abnormal condition that affects the normal operation of the height regulator. Check whether the level of the height regulator is too low. It is recommended that the level of the v2.0 version should be upgraded to v1224 or above, and the level of the 3.0 version should be upgraded to 3180 or above. If frequent occurrence can check whether the network connection is normal, or after changing the network card, the test prompt "the height regulator did not complete (follow) instruction within the specified time" failure.

5.10 The capacitance has always changed to 0



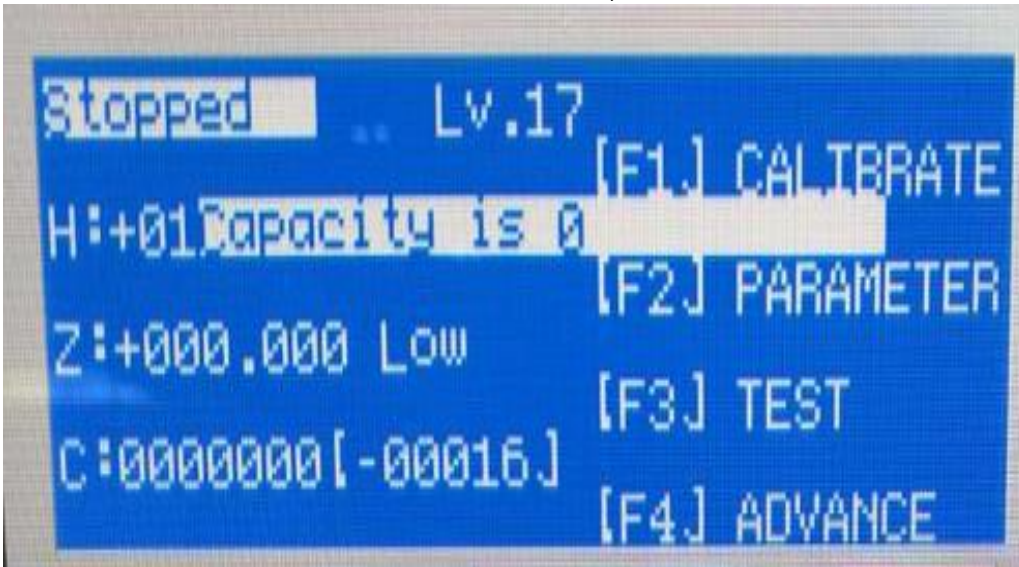

If it is still 0, replace the standard spc-140 rf cable of BCS100 height regulator, check whether the capacitor is restored, and the recovery will be normal

Replace the amplifier and check if the capacitance is restored

5.11 The body capacitance becomes smaller

Touch the nozzle and observe whether the capacitance changes to 0. If it does not change to 0, check whether the ceramic ring and nozzle of the cutting head are installed. Once the cutting head is processed, the alarm will be given to "the capacitance of the body decreases".

When the ambient temperature decreases, the capacitance induction of the amplifier and the cutting head itself will decrease, and the floating head needs to be calibrated again. When the calibration function is on, the parking point should be set above 30mm of the plate surface.

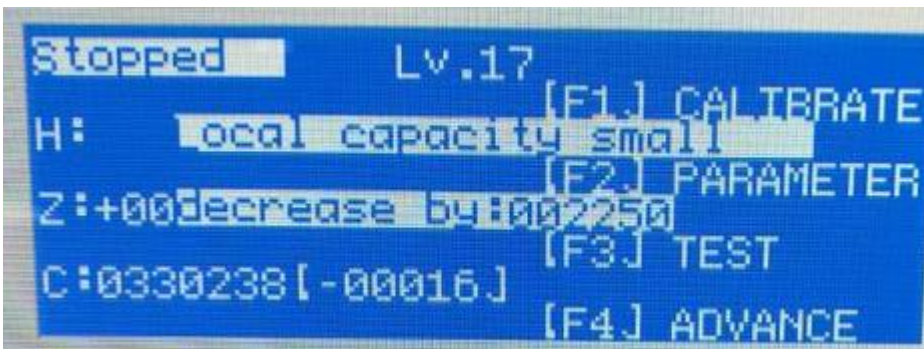

How to turn on real-time calibration

3100edition :
F1demarcate-2Floating head
calibration-F4set up
3180edition:F2parameter-8hig
h-level parameter

标定范围 25.0 mm
跟踪对象: F1金属 F2非金属
实时标定: F3开启 F4关闭
[ENT]保存

语言 0 (中文)
实时标定 1 (启用)
振动抑制 0 (禁用)
振动抑制时间 20ms

Auto Cap Adjust [ON] (Enable)
Tip Touch 0 (Disable)
Vibration Suppress 0 (Disable)
Vib Suppress Time 020 ms
[ENT]NEXT

Calibrate Distance 25.0 mm
Board Material:
[F1] metal [F2] nonmetal
[ENT]SAVE

5.12 The laser head direct touch board

The floating head calibration is performed again, whether the real-time calibration is started when the docking coordinate is set too low. (the criterion is that the switch will be followed immediately after the calibration, and the value in square brackets shall not exceed 300 after the C value of the capacitor is checked).

Stopped Lv.17
H:+01.000+24.000 [F1] CALIBRATE
Z:-000.001 Low [F2] PARAMETER
C:0332424[-00016] [F3] TEST
[F4] ADVANCE

5.13 Capacitance frequent alarm during processing

Check the block F2-7 alarm parameters of the touch panel alarm delay if abnormal, can be appropriately increase the touch panel cut hole or delay.

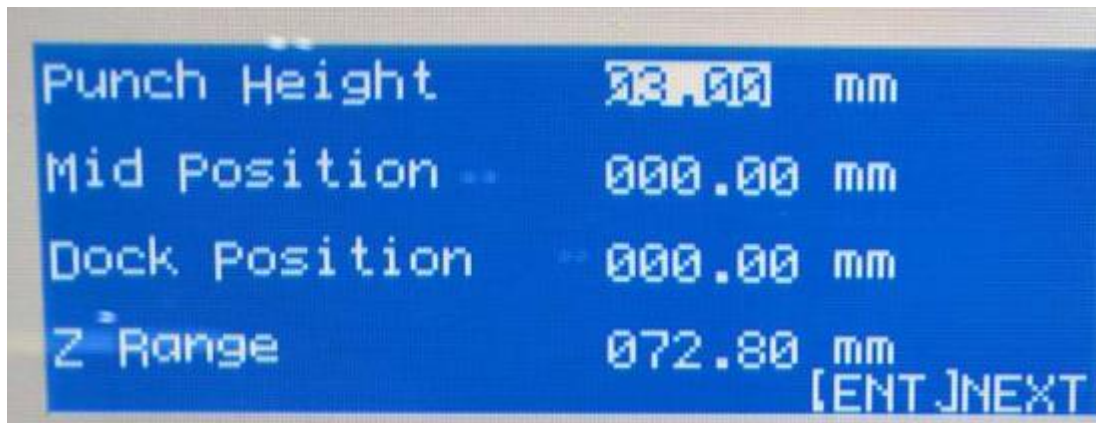

Check whether the cutting head sensor head is not properly installed and whether there is light deviation.

5.14 Cutting thin plate, thick plate edge jitter

Turn on the vibration suppression function in the advanced parameters of the height regulator F2 -- 8. The recommended setting of vibration suppression time is between 10 and 50ms. The higher the value is, the more obvious the suppression effect will be.



5.15 Following the cutting process is getting higher and higher

Check the cutting head is hot or not, and check whether the lens has stains. Cutting laser head is hot will affect the capacitance collection of the induction

5.16 The lifting height is getting lower and lower during the cutting process

After the lifting stops, check whether the value of the height adjuster's Z coordinate is 0. If the value is 0, there is skidding between the z-axis motor and the coupling, and check the mechanical problems

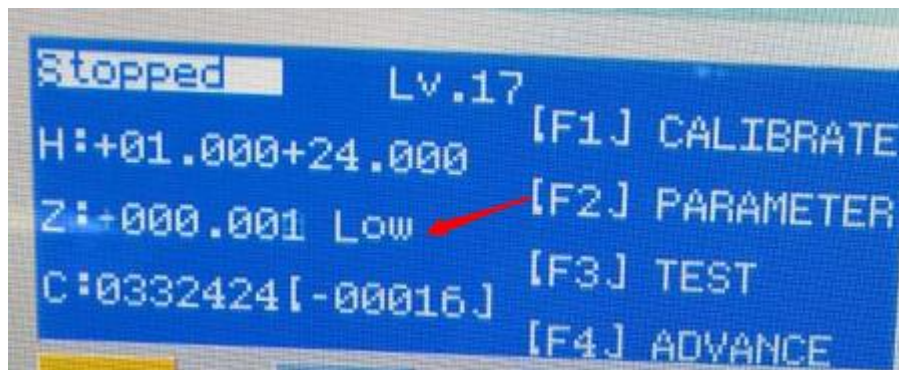

5.17 Floating head calibration can not be marked

Move the cutting head close to the sheet and click the number 5 key on the main interface of the height adjuster to observe the DIF value. If the value is above 30, power off the servo, laser, transformer and other powerful power successively and observe the DIF value. If it is judged that a strong current causes the DIF value to increase, it is necessary to check whether the strong current is well grounded and whether there is leakage, and try to use single-terminal grounding for this equipment.

If the DIF is still large even after all the strong electricity has been turned off, check whether all the four core wires are on, measure whether the enclosure of the amplifier and the bed of the machine are on, and if the conductivity is not good, reduce the impedance by adding grounding wires at both ends.

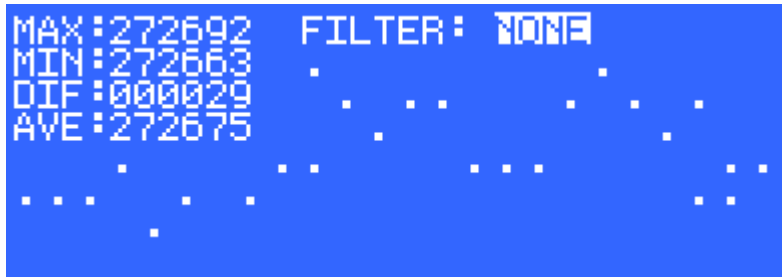

5.18 When the piercing height is greater than 3mm, the piercing process is not performed

Direct cutting is normal. When the perforation height is more than 3mm, it only follows the follow-up action and does not continue. Check whether the calibration range in F4 setting in the height adjuster floating head calibration interface is set to 3mm, and modify it to 25mm.

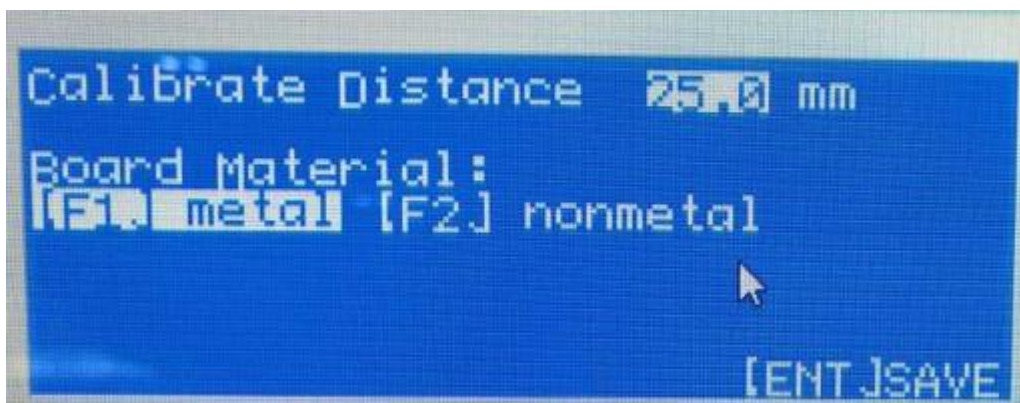
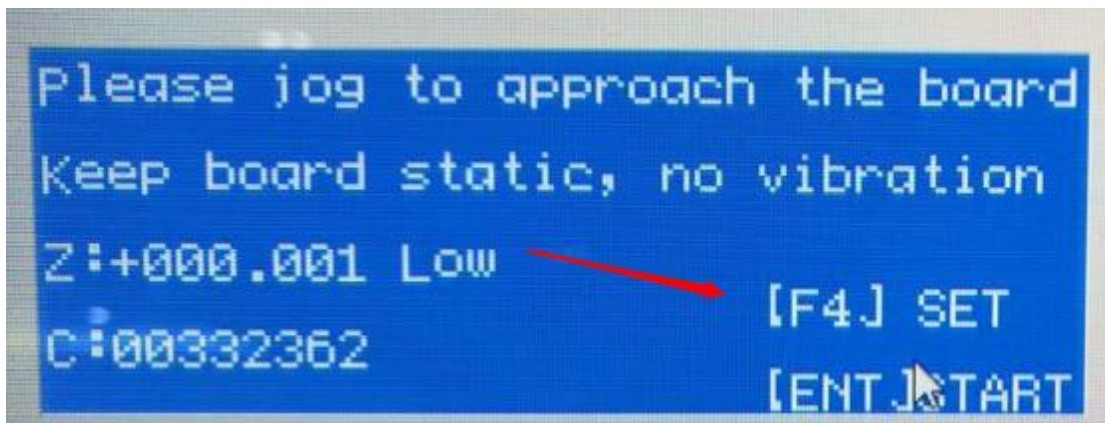

5.19 Servo overload alarm after the height adjuster returns to the origin

Check the upper limit for failure.

Check whether the upper limit position is too close to the top of the screw rod and whether the speed to the origin is too fast

5.20 The up and down movement of the height adjuster moves in one direction

Check whether the servo zero drift is too big, and then do the servo calibration again after clearing the zero drift in the servo calibration interface

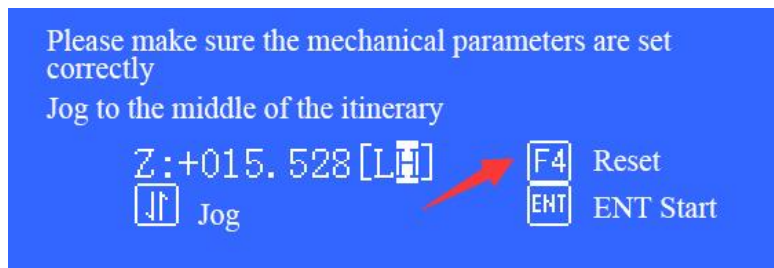

5.21 Adjuster floating head calibration failed

If the alarm indicates that the upper limit is valid, the height adjuster shall be returned to the origin and then the floating head calibration shall be carried out again. The alarm indicates that the capacitance is abnormal. Touch the nozzle by hand to check whether the capacitance changes to 0 or not. If the capacitance does not change to 0, check whether there is something wrong with the internal induction head of the cutting head.

The alarm indicates that the capacitor is always in the state of collision plate, then check whether the capacitor is 0, eliminate the problem so that the capacitor can be normally induced and then re-calibrate the float head.

5.22 Height adjuster prompts to follow the error too large alarm

This alarm refers to that during the following process of the height regulator, the acquisition capacitance changes violently (such as plate shaking, more anti-slag, insufficient air pressure of cutting gas, etc.), which leads to a large deviation between the actual following height and the target following height, thus generating an alarm.

5.23 The height adjuster prompts the encoder to be unresponsive

The encoder not responds to send motion instructions for the height regulator, and the motor does not move.

Check whether the servo driver parameters are set correctly (check whether it is running in speed mode) on the 15-core wire (wiring definition is different from the XY axis, which is in analog quantity control mode). Whether the servo driver parameters are set correctly (check whether it is running in speed mode).

5.24 Encoder abnormal motion

The height regulator does not send motion instructions, but the motor is in motion, it is necessary to check whether there is zero drift in the motor, or the motor falls due to gravity when the servo is not enabled.

5.25 Cutting process problem

- Problem of cutting and perforation

Any hot cutting technique, except in a few cases where it can start cutting at the edge

of the plate, generally requires a small hole to be punched through the plate. In the past, the punching head of a laser stamping composite machine was used to punch out a hole, and then a laser started cut from the hole. There are two basic methods for laser cutting machine without a stamping device:

Blasting perforation--The material is irradiated by a continuous laser beam to form a pit in the center, and then the molten material is quickly removed by a stream of oxygen to form a hole in the molten material. The size of the general hole is related to the thickness of the plate, and the average diameter of blasting perforation is half of the thickness of the plate, so the hole diameter of the blasting perforation of the thicker plate is larger and not round, which is not suitable for high precision parts, and can only be used for waste materials. In addition, the oxygen pressure used for perforation is the same as that used for cutting, the splash is larger.

Pulse perforation--Each pulsed laser only produces small jets of fine particles, which are gradually deepened, so the time for perforation of a thick plate needs a few seconds. Once the perforation is complete, the auxiliary gas is replaced with oxygen for cutting. In this way, the diameter of perforation is smaller, and the quality of perforation is better than that of blasting. The laser source used should not only have higher output power; it is more important is the time and space characteristics of the beam, so the general transverse flow laser cannot meet the requirements of laser cutting. In addition, a reliable air path control system is required for pulse perforation to realize the control of gas type, gas pressure switch and perforation time. In the case of pulse perforation, the transition technology from pulse perforation at rest to constant continuous cutting should be paid attention to obtain high quality incisions. In theory, the cutting conditions of the acceleration section usually can be changed, such as focal length, nozzle position, gas pressure, etc., but in fact, it is difficult to change the above conditions due to too short time. It is practical to change the average power of laser in industrial production. Change the pulse width; Change the pulse frequency and Change the pulse width and frequency at the same time.

5.26 Analysis of deformation of cutting small holes (Small diameter and thick plate)

- Because the machine (only for high-power laser cutting machine) does not use blasting and perforation when making small holes, but by pulse perforation (soft piercing), which makes the laser energy concentrated in a small area. The non-processed area is also burnt, causing deformation of the hole and affecting the processing quality. At this time, we should change the pulse perforation (soft piercing) method to the blasting perforation (normal piercing) method in the processing program. For the smaller power laser cutting machine, the method is opposite. In the small hole processing, pulse perforation should be adopted to obtain a better surface finish.

5.27 Solution for burr of workpiece when laser cutting low carbon steel

According to the work and design principle of laser cutting, the following reasons are the main reasons for the burrs of the work piece: the upper and lower positions of the laser focus are not correct, the focus position test needs to be done, and the offset is adjusted according to the focus; The output power of the laser is not enough. It is necessary to check whether the work of the laser generator is normal. If it is normal, observe whether the output value of the laser control button is correct and adjust it; if the line speed of cutting is too slow, the line speed needs to be increased during operation control; if the purity of the cutting gas is not good, it is necessary to provide high-quality cutting working gas; If the laser focus is offset, the focus position test needs to be performed, and the offset is adjusted according to the focus; If the instability of the machine running time is too long, and the shutdown is required at this time. Restart.

5.28 Analysis of burrs on workpieces when laser-cutting stainless steel and aluminum-zinc plates

When the above problem happens, first consider the factors of burr when cutting carbon steel, but it is not simple to speed up the cutting speed, because the plate may not be cut when the speed is increased. This is especially the case when processing

aluminum-zinc plate. At this time, should considering other factors of the machine, such as the replacement of the nozzle and the unstable movement of the guide rail.

5.29 Analysis of laser incompletely cut through state

After analysis, it can be found that the following cases are the main reasons of processing instability: the size of laser head nozzle does not match the processing plate thickness; the laser cutting line speed is too fast, the operation control is required to reduce the line speed; the nozzle sensing is not allowed. To the laser focus position error is too large, need to re-detect the nozzle sensing data, especially when cutting aluminum is most likely to appear.



5.30 Solution to abnormal sparks when cutting low carbon steel

This condition will affect the quality of the cut section finish of the part. At this time, if other parameters are normal, the following should be considered: the loss of the laser head nozzle NOZZEL should be replaced in time. In the case of no new nozzle replacement, the working gas pressure should be increased; the thread at the joint between the nozzle and the laser head is loose. At this point, the cutting should be paused immediately, the laser head connection status should be checked, and the thread should be re-threaded.

5.31 Summary of cutting process defects

Phenomenon	Reason	Solve
only have burrs on the bottom of	nozzle center not good	adjust the center of nozzle

Cutting stainless with Nitrogen

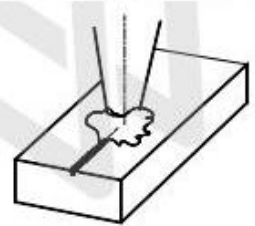
Phenomenon	Reason	Solve
there is irregular burrs on the two sides of cutting edge bottom 	focus is too low, speed is too high	increase the focus position and decrease the cutting speed
there is long burrs on the two sides of cutting edge 	speed is too low, focus is too high, gas pressure is too low, and material is too hot.	increase speed, decrease focus, increase gas pressure and cooling material
only on the two sides of the cutting edge, there is long burrs 	nozzle is not in the center, focus is too high, and gas pressure and speed is too low	adjust nozzle, decrease the focus position, increase gas pressure and speed
yellow color on the cutting edge	there is O ₂ in N ₂	use high purity n ₂
produce plasma gas, can not cut trough 	speed too high, power and focus is too low	decrease cutting speed, increase power and focus position
Bestrahlungsunterbrechung	speed is too high, power and focus position is too low	decrease speed, increase power, increase focus position
rough cutting edge	nozzle break, lens being polluted	change nozzle, clean or change lens

Chapter 6 Maintenance Service

1. During the warranty, there is some parts is broken, and need back to factory to repair, the buyer should pay for the transportation fee to factory. After testing in factory and found, the broken part is broken as itself quality problems(not man-made reason, not use environment reason), the factory will repair it for free or send the buyer a new one for free. At the same time, the factory will undertake the transportation fee to the buyer's company.
2. The back part should be test in FULL SPECTRUM factory firstly, after testing and repairing by FULL SPECTRUM after sale service department, then return it to the buyer.
3. During the warranty period, if the part is broken not as the products itself quality problems, the buyer should pay for the transportation fee to turn back the the buyer's company.
4. During the warranty period, the buyer should pay for the transportation fee to repair the part.
5. The spare parts doesn't have warranty, such as reflective lens, focus lens, protect lens, collimiting lens, laser head, ceramic ring, nozzle etc..
6. The peripheral devices should be maintain according to the devices' manufacturer and at the help of FULL SPECTRUM, the devices has one year's warranty. The warranty will be started to calculated from the date of production such as water chiller, exhaust fan, pimp, air compressor, industry computer etc..